

PROFITEST PRIME, PRIME AC

Testers for IEC 60364-6, EN 50110-1, IEC 60204-1,
IEC 61439-1, DIN EN 62446-1 and DIN EN 61851-1

3-349-933-03
5/4.19



**Test Instrument for Use by
Electrically Qualified
Persons Only!**



Connection, Control and Display Panel, PROFITEST PRIME

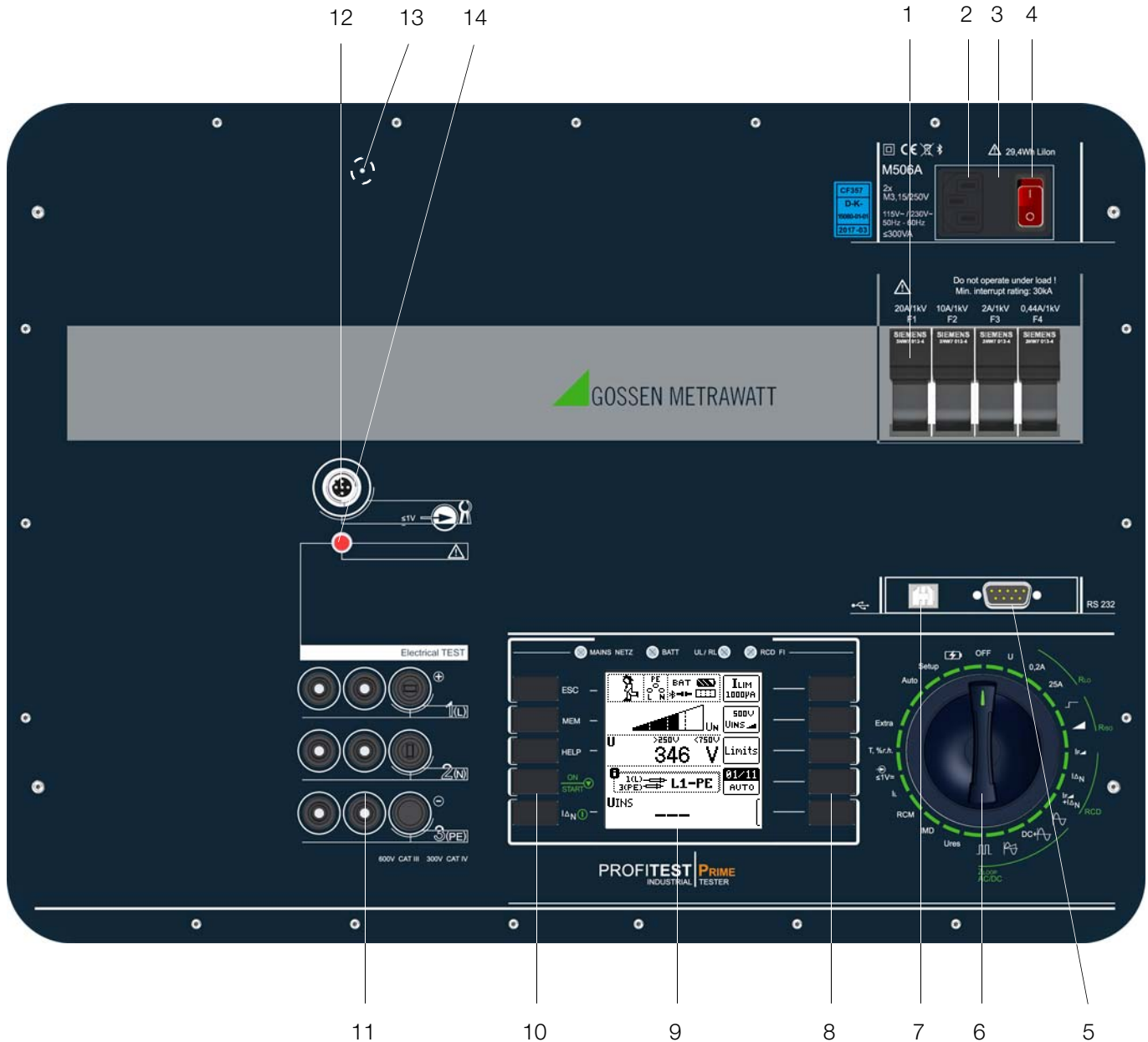

Key

- 1 Measuring circuit fuses
- 2 Connector for inlet plug with country-specific mains plug
- 3 Mains connection fuses
- 4 Illuminated on/off switch
- 5 RS 232 port for connecting:
 - T/H sensor (Z506G) (measurement in **T%rH** switch position)
 - Barcode reader for data entry
- 6 Rotary selector switch (positions: off, measuring functions, charge and setup)
- 7 USB slave for connection to a PC (firmware update, report generation, loading test sequences created at a PC)
- 8 Softkeys (menu-dependent keys for selecting parameters and limit values, and for saving)
- 9 Display panel
- 10 Fixed function keys (ESC, MEM, HELP, ON/START and $I_{\Delta N}$)
- 11 Coded probe connector sockets, each 2-pole with 4-wire technology (probes for 1(L), 2(N) and 3(PE) as well as L1, L2 and L3).
Jack socket 1(L) permits connection of an optional I-SK4 remote control unit (Z506T) with a 4 meter cable or an I-SK12 (Z506U) with a 12 meter cable including the following functions: **Start-Stop** / $I_{\Delta N}$ / **Save-Send** and measuring point illumination.
- 12 Current clamp sensor connector socket for (leakage) current measurement (PROFICLIP, Z3512A*, WZ12C*, METRAFLEX P300*) (measurement in $\leq 1V$ switch position)
Only the current clamp sensors offered as accessories may be connected to these sockets.
* With adapter from banana plug socket to Z506J function plug
- 13 Reset key: see section 26.2 on page 108 regarding use.
- 14 LED „Electrical TEST“ lights up red: basic measuring functions are active, use of probes 1(L), 2(N) and 3(PE) at the sockets with the same designations, lights up briefly when the system is started (function test),
Attention: If the red “Electrical TEST” LED doesn’t light up during the function test, do not perform any more measurements and contact our service department (for address see section 29). But doesn’t light up when the T/F sensor (Z506G) is connected.
- 15 **Bluetooth**® interface (location not specified)

Connection, Control and Display Panel, PROFITEST PRIME AC

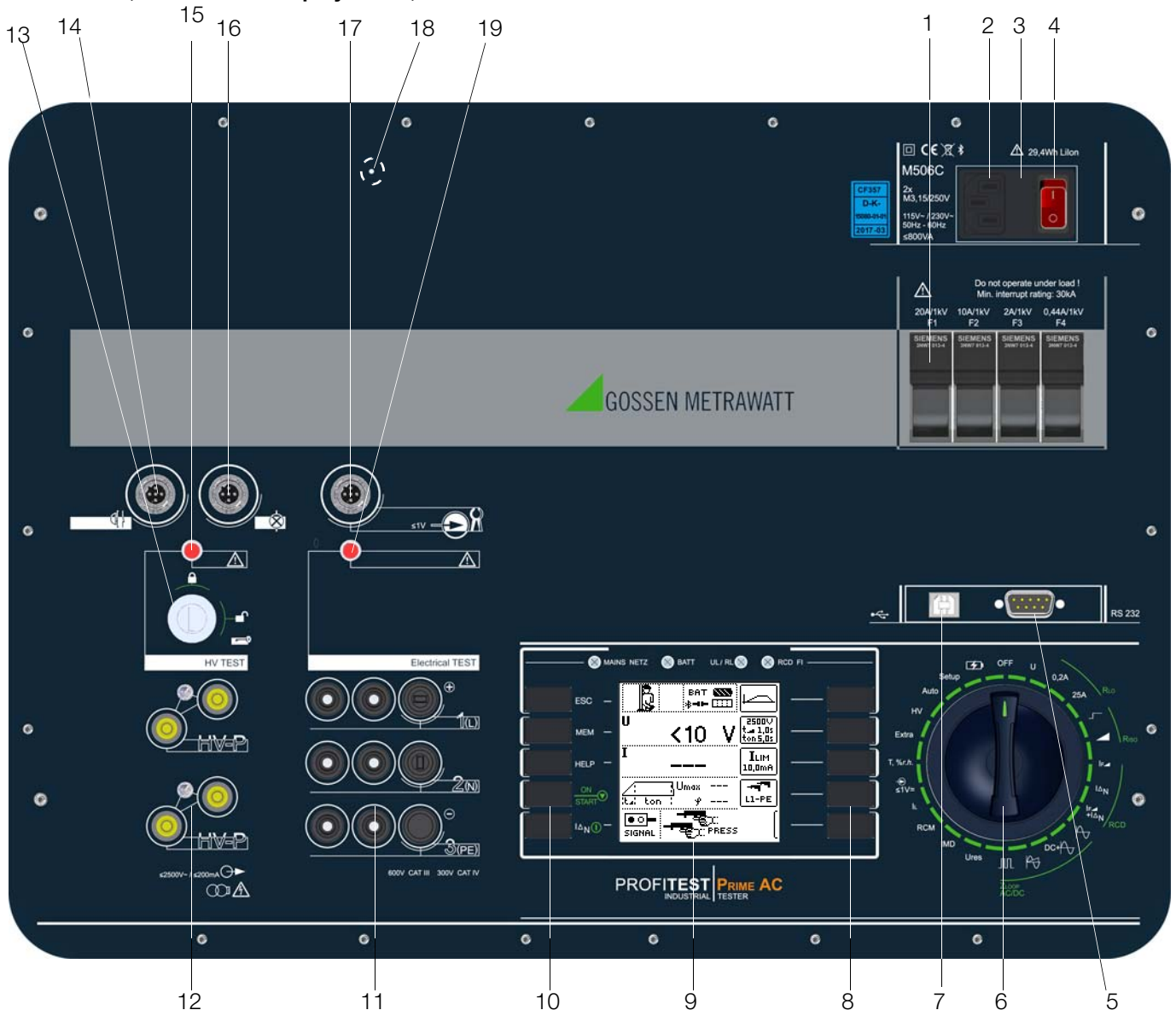

Key

- 1 Measuring circuit fuses
- 2 Connector for inlet plug with country-specific mains plug
- 3 Mains connection fuses
- 4 Illuminated on/off switch
- 5 RS 232 port for connecting:
 - T/H sensor (Z506G) (measurement in **T%rH** switch position)
 - Barcode reader for data entry
- 6 Rotary selector switch (positions: off, measuring functions, charge and setup)
- 7 USB slave for connection to a PC (firmware update, report generation, loading test sequences created at a PC)
- 8 Softkeys (menu-dependent keys for selecting parameters and limit values, and for saving)
- 9 Display panel
- 10 Fixed function keys (ESC, MEM, HELP, **ON/START** and $I_{\Delta N}$)
- 11 Coded probe connector sockets, each 2-pole with 4-wire technology (probes for 1(L), 2(N) and 3(PE) as well as L1, L2 and L3 cannot be mixed up), jack socket 1(L) permits connection of an optional I-SK4 remote control unit (Z506T) with a 4 meter cable or an I-SK12 (Z506U) with a 12 meter cable including the following functions: **Start-Stop** / $I_{\Delta N}$ / **Save-Send** and measuring point illumination.
- 12 Coded probe connector sockets for HV (probes 1 and 2), each 2-pole with 4-wire technology for high-voltage pistols (probes for HV AC and HV DC are coded in order to rule out the connection of incorrect probes)
- 13 Key switch for enabling HV test voltage
- 14 Connector socket for emergency off switch: STOP PROFITEST PRIME AC (Z506D)
- 15 LED „HV TEST“ lights up red: HV AC test is selected, use of high-voltage pistols at the HV-P sockets, blinks during active measurement, lights up briefly when the system is started (function test)

Attention: If the red “HV TEST” LED doesn’t light up during the function test, do not perform any more measurements and contact our service department (for address see section 29).
- 16 Connector socket for signal lamp combination: SIGNAL PROFITEST PRIME AC (Z506B)
- 17 Function connector socket for current clamp sensor for (leakage) current measurement (PROFICLIP, Z3512A*, WZ12C*, METRAFLEX P300*) (measurement in $\ominus \leq 1V \equiv$ switch position) *Only the current clamp sensors offered as accessories may be connected to these sockets.*

* With adapter from banana plug socket to Z506J function plug
- 18 Reset key: see section 26.2 on page 108 regarding use.
- 19 LED „Electrical TEST“ lights up red: basic measuring functions are active, use of probes 1(L), 2(N) and 3(PE) at the sockets with the same designations, lights up briefly when the system is started (function test),

Attention: If the red “Electrical TEST” LED doesn’t light up during the function test, do not perform any more measurements and contact our service department (for address see section 29). But doesn’t light up when the T/F sensor (Z506G) is connected.
- 20 Bluetooth® interface (location not specified)

Control and Display Panel

LEDs and connection symbols → section 24

MAINS NETZ

- Mains connection indicator
- Interference voltage indicator for RLO and RISO

Battery charge level

Touch voltage limit value violation

Lights up when RCD is tripped

Fixed Function Keys 10

ESC:	Return to submenu
MEM:	Key for memory functions
HELP:	Access context sensitive help
ON/START:	Switch on Start/stop measurement
I Δ _N :	Tripping test Next step (semiautomatic measurement) Start offset measurement

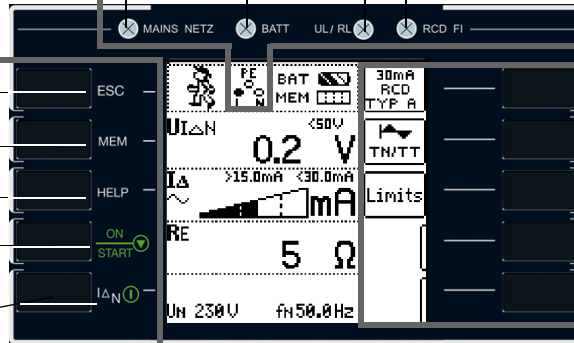

8 Softkeys

- Parameter selection
- Limit value specification
- Entry functions
- Memory functions

LEDs, see section 24

MAINS NETZ LED

The **MAINS NETZ LED** indicates the current status of voltage connected to the test probes. It lights up green, red or orange, or blinks green or red depending upon how the instrument has been connected and the selected function (see also section 24, "Functionality of the Probes, Indication by Means of LEDs and LCD Symbols", as of page 91). This LED also lights up if line voltage is present during measurement of **RLO** and **RISO**.

BATT LED

The **BATT LED** indicates the charging status of the integrated rechargeable battery.

Lights up yellow:	During battery operation when low
Blinks green:	- Slowly while charging - Rapidly in the quick charge mode
Lights up red:	Battery error

UL/RL LED

The **UL/ RL LED** indicates that limit values have been exceeded or fallen short of. This LED lights up red if touch voltage is greater than 25 V or 50 V during RCD testing, as well as after safety shut-down occurs. It also lights up when RLO or RISO limit values have been exceeded or fallen short of.

RCD FI LED

The **RCD FI LED** lights up red in the case of faulty tripping performance of the residual current device under test. This LED lights up red if the RCCB is not tripped within 400 ms (1000 ms for selective RCCDs – type RCD S) during the tripping test with nominal residual current. It also lights up if the RCCB is not tripped before nominal residual current has been reached during measurement with rising residual current.

Keys

ESC Key

Return from the submenu



MEM Key

Access the memory structure
The measurement is stopped when the MEM key is pressed.



HELP Key

The following information can be displayed for each switch position and basic function **after it has been selected with the rotary selector switch**:

Wiring diagram, measuring range, nominal range of use and measuring uncertainty, as well as nominal value



ON/Start Key ▼

The measuring sequence for the function selected in the menu is started by pressing this key on the control panel. Exception: voltage measurement U or U_{res}.

This key has the same function as the ▼ key on the Z506T* or Z506U* intelligent test probe.



I Δ _N / I Key

The following sequences are triggered by pressing this key on the control panel:

- Starts the tripping test after measurement of touch voltage for RCCB testing (I Δ _N).
- Measurement of **ROFFSET** is started within the **RLO** function.
- Semiautomatic polarity reversal (see section 8.6)

This key has the same function as the **II** key on the Z506T* or Z506U* intelligent test probe.



* Optional accessories, not included

Key

Display Panel

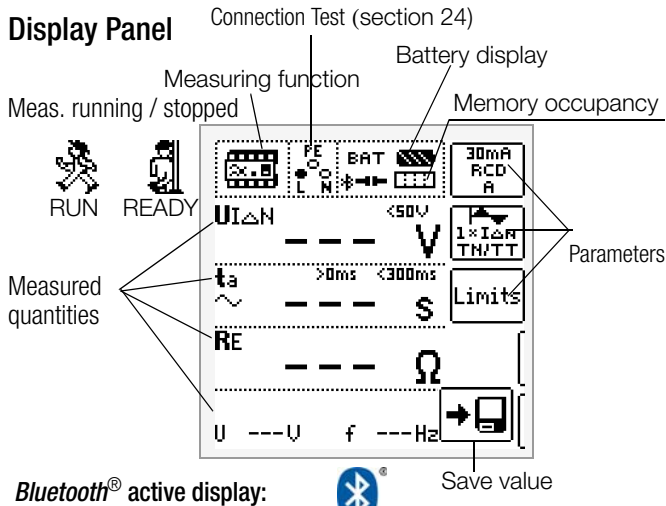

Bluetooth® active display:



Save value

Battery display

- BATT Battery full BATT Battery weak
- BATT Battery OK BATT Battery (almost) dead
 $U < 9.6 V$

Memory Occupancy Display

- MEM Memory full > transfer data to PC
- MEM Memory half full

Connection Test – Mains Connection Test (→ section 24)

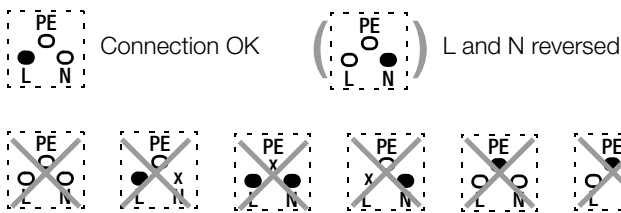

These operating instructions describe a tester with software version SW-VERSION (SW1) 03.03.00.

Overview of Device Settings and Measuring Functions

Switch Setting	Pictograph	Device Settings Measuring Functions
Device Settings		
Off		Measuring instrument is switched off, charging function inactive. The integrated rechargeable batteries are charged in all rotary switch positions.
Quick Charge		The batteries are charged and the charging monitor is displayed. Prerequisite: the charging cable is connected and the mains switch is set to on.
Setup		Test: LEDs
		Test: LCD, acoustic signal, charge level / battery voltage
		Bluetooth®, database mode, brightness/contrast, time/date, user language, profiles, turn-off time, default settings
		Firmware, calibration date, adjustment date
		Enter, select, delete inspector
page 20		

Switch Setting	Pictograph	Device Settings Measuring Functions	
Measuring Functions			
Measurements with line voltage			
U		Voltage measurement – 2-pole	
		UL-PE 2-pole voltage measurement	
		Voltage measurement – 3-phase system	
		UL3-L1 Voltage between L3 and L1	
		UL1-L2 Voltage between L1 and L2	
		UL2-L3 Voltage between L2 and L3	
		f Frequency	
		Phase sequence	
		page 29	
		Appears for all measurements below:	U / U_N Line voltage / nominal line voltage
	f / f_N Line frequency / nominal line frequency		
RCD IF		UIΔN Touch voltage	
page 44		IΔ Residual current	
		RE Earth loop resistance	
RCD IΔN		UIΔN Touch voltage	
page 46		ta ~ Time to trip	
		RE Earth loop resistance	
RCD IF + IΔN		UIΔN Touch voltage	
page 48		ta ~ Time to trip	
		IΔ Residual current	
		RE Earth loop resistance	
ZLOOP		Z Loop / line impedance ZL-PE/ZL-N	
page 58		IK Short-circuit current	
ZLOOP DC+		Z Loop impedance ZL-PE with suppression of tripping of type A RCD	
page 59		IK Short-circuit current	
ZLOOP		Z Loop / line impedance ZL-PE/ZL-N with suppression of tripping of type B RCD	
page 60		IK Short-circuit current	
ZLOOP		Z Loop impedance with $I_{\Delta N}/2$ for avoiding RCD tripping	
page 61		IK Short-circuit current	
Measurements at voltage-free objects			
RLO 0.2A		RLO 0,2A Low-resistance measurement with 200 mA and automatic polarity reversal	
RLO 25 A		RLO 25A Low-resistance measurement with 25 A (HIGH) *	
page 31		ROFFSET Offset resistance for extension cords	
		* Only possible with mains connection	
Riso		RISO Insulation resistance (constant test current)	
page 37		RISO ramp	
Riso ramp		U Voltage at the test probes	
page 39		UINS Test voltage	
		Ramp: triggering/breakdown voltage	
Ures		Ures Undervoltage / residual voltage after discharge time tu	
page 62		U Momentary voltage (supply voltage)	
		tu Discharge time: value must drop to $U \leq U_{lim}$	
IMD		RL-PE Specify insulation resistance	
page 63		tA Tripping time will be calculated	
RCM		UIΔN RCM (residual current monitoring)	
page 66			
IL		IL Residual, or leakage current	
page 69		f Frequency	
$\leq 1V$		IL/AMP Residual or leakage current	
page 70			
T%rh		∅ Temperature	
page 72		r. H. Relative humidity	
EXTRA		ΔU Voltage drop measurement	
page 73		e-mobility (IEC 61851)	
		PRCD Testing of type S and K PRCDs	
HV		HV AC AC testing for dielectric strength (with PROFITEST PRIME AC only)	
page 79			
AUTO		Test sequences / automatic test sequences	
page 84			

1	Scope of Delivery	8	10	RLO – Measuring Low-Value Resistance	31
2	Applications	10	10.1	RLO 0.2A – Measuring Low-Value Resistance with 0.2 A Test Current	31
2.1	Using Cable Sets and Test Probes	10	10.1.1	General	31
2.2	Application of Inside Pocket	10	10.1.2	Help Function	31
2.3	Features Overview of Instrument Variants IZYTRONIQ	11	10.1.3	Parameters	31
3	Safety Features and Precautions	12	10.1.4	R _{OFFSET} Measurement	32
3.1	Special Safety Precautions and Instructions for Voltage Tests with the PROFITEST PRIME AC Test Instruments 13		10.1.5	RLO 0.2 A Measurement	33
3.2	Special Safety Precautions and Instructions for PROFITEST PRIME AC	13	10.1.6	Evaluation of Measured Values	33
3.3	Explanation of Symbols	14	10.1.7	RLO 0.2A Measurement at PRCDs	34
4	Initial Startup	15	10.2	RLO 25A – Measuring Low-Value Resistance with 25 A Test Current ..	35
4.1	Power Supply	15	10.2.1	Measurement Principle	35
4.1.1	Switching the Instrument On/Off – Stand-By	15	10.2.2	Help Function	35
4.1.2	Charging the Batteries	15	10.2.3	Parameters	35
5	Connection Instructions	16	10.2.4	R _{OFFSET} Measurement	35
5.1	Connecting the Test Instrument to Mains Power (Auxiliary Power)	16	10.2.5	RLO 25A Measurement	36
5.1.1	Systems with Earthing Contact Outlet	16	10.2.6	Evaluation of Measured Values	36
5.1.2	Systems with 3-Phase Power Connection	16	11	RISO – Measurement of Insulation Resistance	37
5.2	Connecting Probes and Warning Devices to the Test Instrument ...	17	11.1	Insulation Measurement with Constant Test Voltage	37
5.2.1	General	17	11.1.1	General	37
5.2.2	Standard Test Probes	17	11.1.2	Help Function	37
5.2.3	Smart Test Probes I-SK... ..	17	11.1.3	Parameters	37
5.2.4	High-Voltage Pistols for PROFITEST PRIME AC	17	11.1.4	Riso Measurement	38
5.2.5	Key Switch on PROFITEST PRIME AC	17	11.2	Riso Ramp – Insulation Measurement with Rising Test Voltage ...	39
5.2.6	External Signal Lamps for PROFITEST PRIME AC	17	11.2.1	General	39
5.2.7	Emergency Off Switch for PROFITEST PRIME AC	17	11.2.2	Help Function	39
5.2.8	Current Clamp Sensors	17	11.2.3	Parameters	39
6	Indication of Operating States for the PROFITEST PRIME AC	18	11.2.4	RISO Ramp Measurement	40
7	Device Settings – Setup	20	11.2.5	Notes on Measurement with the Ramp Function	41
8	General Notes	25	11.3	Evaluation of Measured Values	41
8.1	Automatic Settings, Monitoring and Shut-Off	25	12	RCD – Testing of Residual Current Devices	42
8.2	Measured Value Display and Memory	25	12.1	General	42
8.3	Help Function	26	12.2	Measurement of Touch Voltage and Time to Trip with Nominal Residual Current	42
8.4	Setting Parameters or Limit Values using RCD Measurement as an Example	26	12.2.1	General	42
8.5	Freely Selectable Parameter Settings or Limit Values	27	12.2.2	Help Function	42
8.5.1	Changing Existing Parameters	27	12.2.3	Parameters	42
8.5.2	Adding New Parameters	27	12.2.4	RCD I _{ΔN} – Measurement of Time to Trip with Nominal Current	43
8.6	2-Pole Measurement with Fast or Semiautomatic Polarity Reversal	28	12.3	RCD I_F – Testing Residual Current Devices by Measuring Tripping Current with Rising Test Current	44
9	U – Measuring Voltage and Frequency	29	12.3.1	General	44
9.1	U	29	12.3.2	Help Function	44
9.1.1	General	29	12.3.3	Parameters	44
9.1.2	Help Function	29	12.3.4	RCD I _F Measurement	45
9.1.3	Parameters	29	12.4	RCD I_{ΔN} – Testing RCDs by Measuring Time to Trip with Constant Test Current	46
9.1.4	U Measurement	29	12.4.1	General	46
9.2	U_{3~}	30	12.4.2	Help Function	46
9.2.1	General	30	12.4.3	Parameters	46
9.2.2	Help Function	30	12.4.4	RCD I _{ΔN} Measurement	47
9.2.3	U _{3~} Measurement	30	12.5	RCD I_F + I_{ΔN} – Testing RCDs by Simultaneously Measuring Tripping Current and Time to Trip with Rising Test Current	48
9.2.4	Notes:	30	12.5.1	General	48
			12.5.2	Help Function	48
			12.5.3	Parameters	48
			12.5.4	RCD I _F + I _{ΔN} Measurement	49

12.6	Special Tests for Systems and RCDs	50	16.5	Notes Concerning Measurement	68
12.6.1	Testing Systems and RCCBs with Rising Residual Current (AC) for Type B/B+ and EV/MI RCDs	50	17	IL – Leakage Current	69
12.6.2	Testing RCCBs with $5 \cdot I_{\Delta N}$	50	17.1	General	69
12.6.3	Testing of RCCBs which are Suited for Pulsating DC Residual Current	51	17.2	Help Function	69
12.6.4	Systems with Type RCD-S Selective RCCBs	51	17.3	Parameters	69
12.6.5	PRCDs with Non-Linear Type PRCD-K Elements	52	17.4	IL Measurement	69
12.6.6	SRCD, PRCD-S (SCHUKOMAT, SIDOS or comparable)	53	18	IL/AMP – Current Measurement with Current Clamp Sensor	70
12.6.7	Type G or R RCCB	53	18.1	General	70
12.6.8	Testing Residual Current Circuit Breakers in TN-S Systems	54	18.2	Help Function	70
12.7	Notes Concerning Measurement	55	18.3	Parameters	70
12.7.1	General	55	18.4	IL/AMP Measurement	71
12.7.2	RCDs of Special Design	55	19	T %r.H. – Measurement of Temperature and Atmospheric Humidity	72
12.7.3	Presettings	55	19.1	General	72
13	Zloop – Testing of Breaking Requirements for Overcurrent Protective Devices, Measurement of Line or Loop Impedance and Determination of Short-Circuit Current	56	19.2	Help Function	72
13.1	General	56	19.3	Parameters	72
13.1.1	Measurements with Suppression of RCD Tripping	56	19.4	T % r.h. Measurement	72
13.1.2	Settings for Calculating Short-Circuit Current – Parameter I_K	57	20	Extra – Special Functions	73
13.1.3	Special Case: Measurement without Limit Values	57	20.1	ΔU – Voltage Drop Measurement	74
13.1.4	Evaluation of Measured Values	57	20.1.1	General	74
13.1.5	Accessing the Table of “Allowable Fuses”	57	20.1.2	Help Function	74
13.2	Zloop AC/DC – Measuring Line/Loop Impedance	58	20.1.3	Parameters	74
13.2.1	Help Function	58	20.1.4	ZOFFSET Measurement	75
13.2.2	Parameters	58	20.1.5	ΔU Measurement	75
13.2.3	ZLOOP AC/DC Measurement	58	20.2	E-Mobility – Checking the Operating States of an Electric Vehicle at Charging Stations per IEC 61851	76
13.2.4	Notes	58	20.3	PRCD – Test Sequences for Documenting Fault Simulations at PRCDs with the PROFITEST PRCD Adapter	77
13.3	Zloop DC+ – Measuring Line Impedance	59	20.3.1	Selecting the PRCD to be Tested	77
13.3.1	General	59	20.3.2	Parameter Settings	77
13.3.2	Parameters	59	20.3.3	PRCD-S Test Sequence (single-phase) – 11 Test Steps	78
13.3.3	ZLOOP DC+ Measurement	59	20.3.4	PRCD-S Test Sequence (3-phase) – 18 Test Steps	78
13.3.4	Notes	59	21	HV AC – Testing for Dielectric Strength (with PROFITEST PRIME AC)	79
13.4	Zloop – Measuring Loop Impedance	60	21.1	General	79
13.4.1	General	60	21.1.1	Help Function	79
13.4.2	Help Function	60	21.2	Connection	79
13.4.3	Parameters	60	21.3	Parameters	80
13.4.4	ZLOOP Measurement	60	21.4	Function Test (test preparation)	81
13.4.5	Notes	60	21.5	Test Sequence	82
13.5	Zloop – Measuring Loop Impedance	61	21.5.1	Ending the Test for Dielectric Strength	83
13.5.1	General	61	21.5.2	Setting Ranges for Parameters and Standard Values per DIN VDE ..	83
13.5.2	Help Function	61	22	AUTO – Test Sequences (automatic test sequences)	84
13.5.3	Parameters	61	22.1	General	84
13.5.4	ZLOOP Measurement	61	22.2	Creating and Transferring Test Sequences with IZYTRONIQ (step-by-step instructions)	84
13.5.5	Notes	61	23	Database	86
14	Ures – Residual Voltage Measurement	62	23.1	Creating Distributor Structures, General	86
14.1	General	62	23.2	Transferring Distributor Structures	86
14.2	Help Function	62	23.3	Creating a Distributor Structure in the Test Instrument	86
14.3	Parameters	62	23.3.1	Creating Structures (example for electrical circuit)	88
14.4	Ures Measurement	62	23.3.2	Searching for Structure Elements	89
15	IMDs – Testing Insulation Monitoring Devices	63	23.4	Saving Data and Generating Reports	89
15.1	General	63	23.4.1	Use of Barcode Readers	90
15.2	Help Function	63	24	Functionality of the Probes, Indication by Means of LEDs and LCD Symbols	91
15.3	Parameters	63	25	Characteristic Values	102
15.4	IMD Measurement	64			
15.5	Evaluation	65			
15.6	Retrieving Saved Measured Values	65			
16	RCM – Testing of Residual Current Monitoring Devices	66			
16.1	General	66			
16.2	Help Function	66			
16.3	Parameters	66			
16.4	RCM Measurement	67			

26	Maintenance and Recalibration	108
26.1	Firmware Revision and Calibration Information	108
26.2	Reset Key	108
26.3	Rechargeable Battery Operation and Charging	108
26.4	Fuses	108
26.4.1	Mains Connection Fuses	108
26.4.2	Measuring Circuit Fuses	108
26.5	Housing and Test Probes	109
26.6	Measurement Cables	109
26.7	Test Leads for the High-Voltage Pistols	109
26.8	Replacing the Bulbs in the Signal Lamp Combination (Z506B) with the PROFITEST PRIME AC	109
26.9	Temperature/Humidity Sensor with Magnetic Retainer (optional)	109
26.10	Recalibration	109
26.11	Software	109
27	Appendix	110
27.1	Tables for Determining Maximum and Minimum Display Values in Consideration of Maximum Measuring Uncertainty	110
27.1.1	RLO Display Values	110
27.1.2	RISO Display Values	111
27.1.3	RCD Display Values	112
27.1.4	ZLOOP Display Values	114
27.1.5	Ures Display Values	115
27.1.6	RCM Display Values	115
27.1.7	HV (PROFITEST PRIME AC) Display Values	116
27.2	At which values should/must an RCD actually be tripped? Requirements for Residual Current Devices (RCD)	117
27.3	Testing Electrical Machines per DIN EN 60204 – Applications, Limit Values	118
27.4	Periodic Testing per DGUV Regulation 3/4 (previously BGV A3, VBG4, UVV) – Limit Values for Electrical Systems and Operating Equipment	119
27.5	List of Abbreviations and their Meanings in the Order They Appear on the Rotary Switch	120
27.6	Keyword Index	121
27.7	Bibliography	122
27.7.1	Internet Addresses for Additional Information	122
28	Return and Environmentally Sound Disposal	123
29	Repair and Replacement Parts Service Calibration Center and Rental Instrument Service	124
30	Product Support	124

1 Scope of Delivery

- 1 Test instrument
 - 1 Mains power cable, 1.5 m
 - 1 Probe with 4-wire measuring technology for connection to L conductor *
 - 1 Probe with 4-wire measuring technology for connection to N conductor *
 - 1 Probe with 4-wire measuring technology for connection to PE conductor *
 - 1 USB interface cable
 - 1 DAkKS calibration certificate
 - 1 Supplementary sheet with safety information
 - 1 Condensed operating instructions**
- **Comprehensive operating instructions available on the Internet for download at www.gossenmetrawatt.com

- 1 Card with registration key for the software



- * Measuring category with safety cap attached: 300 V CAT IV, 600 V CAT III, 1 A
- Measuring category without safety cap attached: 600 V CAT II 16 A

2 Applications

This test instrument fulfills all requirements of applicable EU directives and national regulations. We confirm this with the CE mark. The relevant declaration of conformity can be obtained from GMC-I Messtechnik GmbH.

PROFITEST PRIME measuring and test instruments are used for rapid and efficient testing of protective measures in accordance with DIN VDE 0100-600

(Erection of low-voltage installations; tests – initial tests), ÖVE-EN 1 (Austria), NIV/NIN SEV 1000 (Switzerland) and other country-specific regulations.

The test instrument is equipped with a microprocessor and complies with requirements set forth in IEC 61557/EN 61557/VDE 0413:

Part 1: General requirements

Part 2: Insulation resistance

Part 3: Loop resistance

Part 4: Resistance of earth connection and equipotential bonding

Part 6: Effectiveness of residual current devices (RCDs) in TT, TN and IT systems

Part 7: Phase sequence

Part 10: Electrical safety in low-voltage systems up to 1000 V AC and 1500 V DC – Equipment for testing, measuring or monitoring of protective measures

Part 11: Effectiveness of residual current monitors (RCMs) type A and type B in TT, TN and IT systems

Part 14: Equipment for testing the safety of electrical equipment of machinery

The test instrument is especially well suited for:

- System setup
- Initial startup
- Periodic testing
- Troubleshooting in electrical systems

All of the values required for approval reports (e.g. per ZVEH) can be measured with this test instrument. All acquired data can be archived, and measurement and test reports can be printed out at a PC.

This is of special significance where product liability is concerned.

The applications range of the test instruments covers all alternating and 3-phase current systems with nominal voltages of 120 V / 230 V / 400 V up to 690 V and nominal frequencies of DC, 16,7 / 50 / 60 / 200 / 400 Hz.

The following can be measured and tested with the test instruments:

- Voltage / frequency / phase sequence
- Loop impedance / line impedance
- Residual current devices (RCDs/PRCDs)
- Insulation monitoring devices (IMDs)
- Residual current monitoring devices (RCMs)
- Insulation resistance
- Low-value resistance (potential equalization)
- Leakage current with current transformer clamp
- Residual voltage
- Voltage drop
- Leakage / differential / touch current

The **PROFITEST PRIME** test instrument is intended for quick and safe testing of electrical and electronic equipment and systems in machines.

According to the regulations, the following initial and periodic tests must be performed:

- Testing for electrical continuity of the protective conductor system
- Insulation resistance tests
- Testing for dielectric strength (**PROFITEST PRIME AC**)
- Testing for residual voltage

The following tests can also be conducted which supplement the test instrument in a practical manner although they're not mandatory for verifying the electrical safety of equipment in machines:

- Leakage current testing for substantiating the absence of voltage
- Voltage and frequency measurements

All of the values required for approval reports can be measured with this instrument.

All measured data can be archived using the measurement and test report which can be printed out at a PC. This is very important, especially due to product reliability.

2.1 Using Cable Sets and Test Probes

- Scope of delivery:
4-wire probes for 1(L), 2(N) and 3(PE) conductor connection

Maximum rated voltage	300 V	600 V	600 V
Measuring category	CAT IV	CAT III	CAT II
Maximum rated current	1 A	1 A	16 A *
With safety cap attached	•	•	—
Without safety cap or with attached alligator clip	—	—	•

Measurements per DIN EN 61010-031 may only be performed in environments in accordance with measuring categories III and IV with the safety cap attached to the test probe at the end of the measurement cable.

In order to establish contact inside 4 mm jacks, the safety caps have to be removed by prying open the snap fastener with a pointed object (e.g. the other test probe).

2.2 Application of Inside Pocket



Attention!

The pocket at the inside cover of the case of the **PROFITEST PRIME** is **not** intended for use as an accessory pouch. This may cause considerable damage to the front glass panel of the display.

Please use the accessory pouch or the accessory case for storing accessories.

2.3 Features Overview of Instrument Variants IZYTRONIQ

PROFITEST... (article number)	PRIME (M506A)	PRIME AC (M506C)
Voltage and Frequency Measurement up to 1 kV		
In single-phase AC/DC systems	X	X
In 3-phase systems (UL1-L3, UL1-L2, UL2-L3)	X	X
Phase sequence testing	X	X
Measurement of Protective Conductor Resistance RLO		
With 0.2 A measuring current: constant/ramp, polarity and test time can be selected	X	X
With 25 A measuring current	X	X
Measurement of Insulation Resistance RISO		
With constant DC test voltage (50 ... 1000 V)	X	X
With DC ramp function	X	X
Testing of Residual Current Devices		
General and selective including RCD, SRCD, PRCD, G/R and RCBO (FI-LS) variants	X	X
Testing of AC/DC sensitive RCDs, types B, B+ and EV	X	X
Measurement of fault voltage without tripping the RCD	X	X
Tripping current measurement with ramp function	X	X
Measurement of time to trip	X	X
Simultaneous measurement of tripping current and time to trip with "intelligent ramp"	X	X
Loop Impedance Measurement		
Measurement with full-wave, test current: 10 A AC/DC	X	X
Measurement in 690 V systems	X	X
Measurement in DC systems	X	X
Without tripping the RCD (type AC, A) by means of "DC saturation process"	X	X
Combined process without tripping the RCD: "impedance Z + R"	X	X
Without tripping the RCD: 15 mA process	X	X
Display of permissible fuse types in a table	X	X
Residual Voltage Test	X	X
Testing of Insulation Monitoring Devices (IMDs)	X	X
Testing of Residual Current Monitoring Devices (RCMs)	X	X
Leakage Current Measurement (direct)	X	X
Current Measurement (with optional current clamp sensor)	X	X
Measurement of Temperature and Atmospheric Humidity	X	X
Voltage Drop Measurement ΔU	X	X
Documentation of Charging Station Tests	X	X
Documentation of Fault Simulations at PRCDs with the Profitest/PRCD Adapter	X	X
HV AC Dielectric Strength Test, 2.5 kV / 200 mA	—	X
with constant AC test voltage	—	X
Breakdown voltage measurement with ramp function	—	X
Pulse control mode for troubleshooting	—	X
Features		
Automatic test sequence function	X	X
Selectable menu language: D, GB, F, NL, I, E, CZ, NO	X	X
Push-print function (storage or transmission via Bluetooth)	X	X
Database (max. 30,000 objects can be saved)	X	X
Operation via optional control probe: (Start/Δ _N /Save/Light)	O	O
RS 232 port for RFID/barcode reader	X	X
Interface for data transmission via Bluetooth®	X	X
Interface for data transmission via USB	X	X
Report generating program IZYTRONIQ	X	X
Measuring category for basic measuring functions: 600 V CAT III / 300 V CAT IV	X	X
HV AC terminals: 2.5 kV / 200 mA	—	X
HV DC terminals: 5 kV	—	—
DAkkS calibration certificate	X	X

X: included

O: available as option

—: not available

3 Safety Features and Precautions

The electronic measuring and test instrument is manufactured and tested in accordance with safety regulations IEC 61010-1/ DIN EN 61010-1/VDE 0411-1.

Safety of the operator, as well as that of the instrument, is only assured when it's used for its intended purpose.

Read the operating instructions thoroughly and carefully before using your instrument. Follow all instructions contained therein. Make sure that the operating instructions are available to all users of the instrument.

Tests may only be executed by a qualified electrician.

The measuring and test instrument may not be placed into service:

- If external damage is apparent
- If connector cables or measuring adapters are damaged
- If the instrument no longer functions flawlessly
- After long periods of storage under unfavorable conditions (e.g. humidity, dust or extreme temperature)
- If the red "Electrical TEST"* or "HV TEST"* LED doesn't light up during the function test, do not perform any more measurements and contact our service department (for address see section 29).
- If any modifications have been applied to the test and measuring instrument itself and/or to its accessories.

* PROFITEST PRIME: Operating Instructions page 2 Key item no. 14
PROFITEST PRIME AC: Operating Instructions page 3 Key item no. 15 or 19

Exclusion of Liability

When testing systems with RCCBs, they may switch off. This may occur even though the test does not normally provide for it. Leakage currents may be present which, in combination with the test current of the test instrument, exceed the shutdown threshold value of the RCCB. PCs which are operated in proximity to such RCCB systems may switch off as a consequence. This may result in inadvertent loss of data. Before conducting the test, precautions should therefore be taken to ensure that all data and programs are adequately saved, and the computer should be switched off if necessary. The manufacturer of the test instrument assumes no liability for any direct or indirect damage to equipment, computers, peripheral equipment or databases when performing the tests.

HV-AC: The manufacturer explicitly excludes any liability in the event of misuse, the use of improper or altered accessories or in the event of manipulation of the test and measuring instrument or its accessories.

Opening the Instrument / Repairs

The instrument may only be opened by authorized, trained personnel in order to ensure flawless operation and to assure that the guarantee is not rendered null and void.

Even original replacement parts may only be installed by authorized, trained personnel.

If it can be ascertained that the instrument has been opened by unauthorized personnel, no guarantee claims can be honored by the manufacturer with regard to personal safety, measuring accuracy, compliance with applicable safety measures or any consequential damages.

If the guarantee seal is damaged or removed, all guarantee claims are rendered null and void.

Meanings of Symbols on the Instrument

 Warning concerning a point of danger (attention, observe documentation!)

 Protection category I device

 Protection category II device



This device may not be disposed of with the trash. Further information regarding the WEEE mark can be accessed on the Internet at www.gossenmetrawatt.com by entering the search term "WEEE".



CE Conformity Marking



By removing the TORX Screw on the right side of the measuring circuit fuses, which is fitted with blue sealing wax, any warranty claims are forfeited.



The special technical knowledge of qualified personnel is required for electrical installation or repair.

Calibration seal (blue seal):

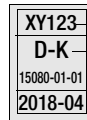

XY123 — Consecutive number
D-K — Deutsche Akkreditierungsstelle GmbH – calibration lab
15080-01-01 — Registration number
2018-04 — Date of calibration (year – month)

see also "Product Support" on page 124

Data Backup

We advise you to regularly transfer your stored data to a PC in order to prevent potential loss of data in the test instrument.

We assume no responsibility for any data loss.

Precautions for Transport

Before closing the cover of the test case, please disconnect all mains cables, measurement and signal cables from the front panel terminals of the test instrument and store them separately in order to prevent them from being jammed and damaged in the process and in order to prevent scratching of the display

Safety Precautions, Rechargeable Lithium-Ion Battery

The test instrument is powered by a rechargeable lithium-ion battery. Consequently, it's absolutely essential to observe the following points:

- **Temperature ranges:** The test instrument must not be exposed to direct **sunlight** or charged, operated or stored at **high temperatures**, for example in a car.
 - **Charging mode (10 ... 45 °C):** The battery may only be charged within this temperature range.
 - **Measuring mode (-5 ... 50 °C):** The battery may only be used within this temperature range. The battery is switched to the **protective mode** as of **55 °C**. In this case the test instrument can no longer be operated with the battery.
 - **Storage (-20 ... 60 °C):** The maximum **storage temperature** is **60 °C**.
 - **Safety circuit:** At temperatures of above **75 °C**, the rechargeable battery is shut down entirely for safety reasons and must be replaced by our service department.
- **Excessive depletion:** The rechargeable battery's safety circuit consumes minimal amounts of current. In order to prevent the battery from becoming fully depleted, the instrument should be connected to the mains for recharging at least once a year, and preferably at more frequent, regular intervals. In some cases it's no longer possible to recharge a fully depleted battery, in which case it must be replaced by our service department.
- **Battery replacement:** The **battery cannot be replaced by the customer** for reasons involving safety, transport and environmental protection. If the rechargeable battery inside the instrument is defective, it must be replaced by GMC-I Service GmbH.

3.1 Special Safety Precautions and Instructions for Voltage Tests with the PROFITEST PRIME AC Test Instruments



Attention!

The test instrument itself must not be used as a device under test for voltage testing by means of HV AC!

Checklist for High-Voltage Tests (PROFITEST PRIME AC)



Attention!

Measurements may not be performed under moist ambient conditions, where condensation has occurred or in explosive atmospheres.

Personal Safety

- ⇨ Turn the machine under test off and secure against restart.
- ⇨ Perform protective conductor and insulation resistance measurements.
- ⇨ Make sure that the system is grounded.
- ⇨ Secure the danger zone with barriers, closing even narrow passageways (optional accessory: CLAIM PROFITEST PRIME AC – Z504G).
- ⇨ Set up warning signs such that they are plainly visible.
- ⇨ Set up warning lamps such that they are plainly visible (**PROFITEST PRIME AC**).
- ⇨ Attach the emergency stop switch in a plainly visible and easily accessible fashion (**PROFITEST PRIME AC**).
- ⇨ Warn personnel working in the area of possible danger.
- ⇨ Always turn the high-voltage module of the test instrument off with the key switch and remove the key before leaving the work area (**PROFITEST PRIME AC**).
- ⇨ the two high-voltage pistols can be operated by the inspector with one hand each (two-hand operation)

Safety Precautions for the Machine Under Test (recommended)

- ⇨ Review the circuit diagrams and make a note of all electrical circuits.
- ⇨ The machine must be switched off in any case – supply power to the machine must be disconnected and secured against reactivation!
- ⇨ Disconnect the neutral conductor (if included) from the mains.
- ⇨ Short circuit each electrical circuit to itself.
- ⇨ Disconnect control circuits with overvoltage arresters, if the arresters would be triggered by the utilized test voltage.
- ⇨ Disconnect PELV circuits (no HV testing is required for these circuits).
- ⇨ Test insulation at each circuit with 1000 V. (If insulation resistance is OK at 1000 V, no failures should occur when testing dielectric strength.)
- ⇨ Disconnect inverters.
- ⇨ **Caution in TN systems!**
The protective conductor is connected to the neutral conductor in this case and high-voltage is thus applied between phase conductor and neutral conductor. The neutral conductor (if included) must be interrupted if necessary, because it's not disconnected from the mains by means of fuses.

Setting Up the Test Instrument

Testing for Dielectric Strength

- ⇨ Test all circuits (conductors) against the protective conductor (all switches in the mains circuit must be turned on, and testing must be performed upstream and downstream from all relays and contactors).
- ⇨ Remove all shorting devices after testing has been completed.

Testing Without Short-Circuiting

- ⇨ Test all conductors from all circuits separately against the protective conductor (the machine could be damaged in the case of arc-over).

Function Test

- ⇨ The machines must be tested for correct functioning after testing for dielectric strength, especially with regard to safety functions.

3.2 Special Safety Precautions and Instructions for PROFITEST PRIME AC

Precaution for the Prevention of *Unauthorized* Startup

- Key switch on the HV TEST connector panel

Precautions for the Prevention of *Inadvertent* Startup

- **Multiple key operation:**
Before test voltage can be applied to the test probes by activating the triggers at the high-voltage pistols, the **ON/START** key must be pressed at the test instrument.
- **High-voltage pistols with double safety feature (two-hand operation):**
If the triggers at the high-voltage pistols are pulled to the first point of mechanical resistance, the test probes are exposed. High-voltage is not applied to the test probes until the triggers are pulled beyond this point, assuming the device is ready for activation.

General Safety Precautions

- **External signal lamps** indicate the switching status of the test instrument.
- **The test probes are electrically isolated** from the supply mains. This prevents current from flowing from the high-voltage pistols to earth.
- **Current limiting in the event of arc-over:**
If the current limit value entered as a device parameter is exceeded due to arc-over, switching to the “standby” mode takes place automatically.
- When **mains voltage is restored after a power failure**, switching to the “standby” mode takes place automatically.



Attention!

Observe the stipulations set forth in DIN EN 50191/VDE 0104, “Erection and operation of electrical test equipment”.



Attention!

If **safety test probes** are used, the operator must inspect them to assure that the test probes and their cables are in flawless condition before placing them into service. Before use, all equipment must be inspected for visible, external damage and checked as to whether it is in pristine condition and free from manipulations of any kind (see section 26.5 on page 109 through section 26.7 on page 109).



Attention!

Be sure to fully extend the measurement cables before testing for dielectric strength.



Attention!

Before initializing any tests, and before **enabling** the test equipment, make sure that all means of access to the danger zone are closed, and that all persons have exited the danger zone.



Caution: High-Voltage!

When the triggers at the high-voltage pistols are pulled to the first point of discernible mechanical resistance, the test probes are exposed.
If the triggers are pulled beyond this point of mechanical resistance, high-voltage is applied to the test probes, assuming the high-voltage module is “ready for activation” (red signal lamp illuminated).



Caution: High-Voltage!

Touch **neither** the test probes **nor** the device under test during the test for dielectric strength!
Life endangering high voltage of up to **2.5 kV** (**PROFITEST PRIME AC**) is present at the test probes of the high-voltage pistols!



Attention!

No **condensation** may occur at the test instrument, the test cables or the device under test, because high-voltage may otherwise cause leakage current at the surfaces. Insulated components may also conduct high-voltage in this case.

3.3 Explanation of Symbols

Symbols in the Operating Instructions



Life endangering for the operator if instructions identified with this symbol are not observed



Danger for the operator and the device if instructions identified with this symbol are not observed

Symbols in the User Interface for High-Voltage Measurement



The high-voltage module is ready to for activation. The high-voltage pistols can be activated.



Life endangering high voltage of up to **2.5 kV** is present at the test probes.

Exclusion of Liability

PCs located in proximity to the test equipment may “crash” in the event of arc-over, resulting in possible data loss. Before testing for dielectric strength, precautions should therefore be taken to ensure that all data and programs are adequately saved, and the computer should be switched off if necessary. PCs may crash even if no USB connection has been established.

The manufacturer of the test instrument assumes no liability for direct or consequential damages to computers, peripheral devices or data loss during testing for dielectric strength.

Furthermore, the manufacturer assumes no liability for defects at devices under test resulting from testing for dielectric strength. This applies in particular to electronic components included in the device under test.

For voltage tests with high-voltage, two-hand operation by the inspector is a mandatory requirement.

The manufacturer is not liable for any damage caused by improper operation.

Moreover, the manufacturer is not liable for damage of any kind which has been caused by the use of accessories not authorized by GMC-I and/or manipulated accessories.

Observe the checklist for voltage tests on page 13.

4 Initial Startup

4.1 Power Supply

Measuring mode operation is possible with either of two different sources of electrical power, which are however restricted depending on auxiliary power or the application: Mains operation or operation with the integrated rechargeable battery.

Auxiliary Power (source)	Scope of Functions				
	Load	Basic functions	RLO 25 A	HV AC	RCD DC 1
Battery operation	✗	✓	✗	✗	✓ ²
Mains operation, 230 V/240 V 50/60 Hz	✓	✓	✓	✓	✓
Mains operation, 115 V / 50/60 Hz	✓	✓	✓	✗	✓
Mains operation 85 ... 264 V / 16.7 ... 400 Hz	✓	✓	✗	✗	✓

✓ Function available

✗ Function not possible or not sensible

¹ Functions for RCD type B, B+ and loop with DC disabling (Loop+DC)

² Performance of ZLOOP DC+ (DC-H), RCD IF and RCD IΔN measurements with DC test current is only recommended with a battery charge level of ≥ 50%.

4.1.1 Switching the Instrument On/Off – Stand-By

- Connect the test instrument to mains power via the inlet plug (see section 5.1 on page 16).
- Set the mains switch to **ON "1"** – the red lamp lights up.
- Set the rotary selector switch to **U** or any other position except for **OFF**.



The menu which corresponds to the rotary selector switch is displayed.

- The instrument can be switched off manually by setting the rotary selector switch to the **OFF** position.
- The instrument is disconnected from the mains by setting the red line disconnecter to **OFF "0"**.

Standby Function

- The instrument is switched to the standby status for all measuring functions except for continuous measurement after the shutdown time specified in **SETUP** (see section 7). The display is turned off in this case.
- There are two ways to switch the instrument back on again:
 - By pressing the **ON/START** key at the test instrument or
 - By turning the rotary selector switch to the **OFF** position and then reselecting the measuring function.

Operation Without Mains Power

Prerequisites:

- The batteries are charged
- The mains switch is set to **OFF "0"**.

4.1.2 Charging the Batteries



Attention!

The internal batteries are charged inside the instrument and cannot be replaced by the user.

The batteries are continuously charged as long as the test instrument is connected to the mains when the mains switch is set to **ON "1"**, regardless of the selector switch position.

Quick Charging

- Connect the test instrument to mains power via the inlet plug (see section 5.1 on page 16).
- Set the mains switch to **ON "1"** – the red lamp lights up.
- In order to quick charge the integrated batteries, set the rotary selector switch to the  position.



The pictogram shown to the right appears at the display if the instrument is not connected to the mains or if the mains switch is not set to **ON "1"**.

In either of these cases, the batteries are not charged.

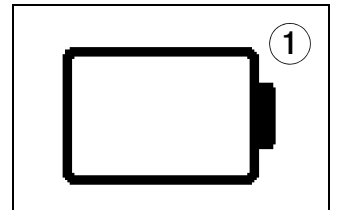

No measurements can be conducted during the quick charging process. This is assured by means of the  switch position.

See also section 26.3 on page 108 with regard to charging the batteries in the test instrument.

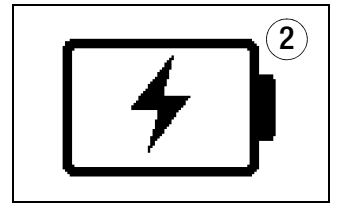

The pictogram shown at the right indicates that the batteries are fully charged.

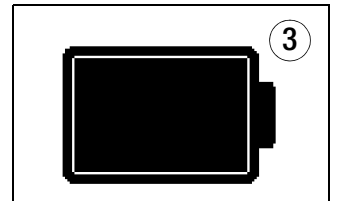

Battery Test

Indication of the momentary charge level:

- By means of LEDs (see page 91)
- By means of symbols at the LCD (see page 94).

If rechargeable battery voltage has fallen below the allowable lower limit, the pictograph shown at the right appears. **BATT**  is also displayed along with a rechargeable battery symbol.

The instrument does not function in the battery operating mode if the batteries have been depleted excessively and no display appears.

Switch to the mains operating mode in this case.

If the batteries have not been used or recharged for a lengthy period of time (> 1 month), thus resulting in excessive depletion:

Please note that the system clock stops in this case and must be set to the correct time after the instrument has been restarted.

5 Connection Instructions

5.1 Connecting the Test Instrument to Mains Power (Auxiliary Power)

5.1.1 Systems with Earthing Contact Outlet

In systems with earthing contact outlets, connect the test instrument to the 230 V or 115 V mains (depending on country version) via the included mains power cable. Insert the inlet plug into the respective outlet next to the line disconnector to this end. Connect the other end of the mains power cable with the country specific plug to the electrical system's earthing contact outlet.



Attention!

The instrument may only be connected to electrical systems with up to 230 V/240 V (e.g. IEC 60346, VDE 0100) and are protected with a fuse or circuit breaker with a maximum rating of 16 A.

Voltage between phase conductor L and the PE protective conductor may not exceed 264 V!

5.1.2 Systems with 3-Phase Power Connection

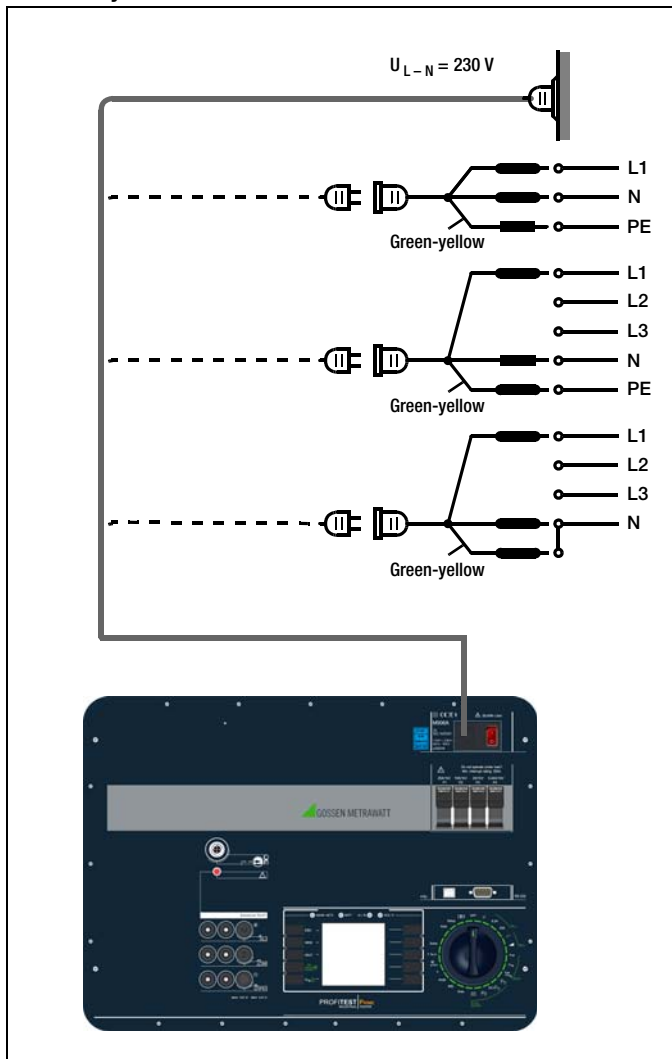

If an earthing contact outlet is not available, or if only a 3-phase outlet is available, the adapter socket can be used to connect the phase conductor, the neutral conductor and the protective conductor. The adapter socket has three permanently attached cables and is included with the KS13 cable set.



Attention!

If connection is not possible via an earthing contact outlet: Shut down mains power first. Then connect the cables from the coupling socket to the mains using pick-off clips in accordance with the diagram.

5.2 Connecting Probes and Warning Devices to the Test Instrument

5.2.1 General

2 LEDs indicate whether the standard test tips of the HV test probes/pistols are active.

Both LEDs light up briefly when the system is started up, in order to indicate that the instrument is ready for operation.

5.2.2 Standard Test Probes

The standard test probes with 4-wire measuring technology for the 1(L), 2(N) and 3(P)E sockets are coded differently by means of their connector plugs, in order to rule out the possibility of connecting them to the wrong sockets.

5.2.3 Smart Test Probes I-SK...

In addition to the functions of the standard probe, the active probe for connection „1(L)“ offers a remote-control option for the test instrument. It allows for starting or aborting measurements and for storing or transmitting the recorded measurement data. It is also possible to illuminate measuring points. Please refer to the associated operating instructions for further details.

5.2.4 High-Voltage Pistols for PROFITEST PRIME AC

The high-voltage pistols for the **HV-P** sockets (HV AC) for probes 1 and 2 are coded differently by means of their connector plugs, in order to rule out the possibility of connecting the wrong probes. The high-voltage pistols are only functional as long as the respective key switch is set to “ON”.

5.2.5 Key Switch on PROFITEST PRIME AC

The key switch prevents unauthorized activation of the high-voltage measuring circuit. Keep the key in a safe place which is only accessible to authorized personnel.

Turn the key to the “OFF” position and remove after testing has been completed.

Note

If you require a **spare key**, you have to obtain a key blank (Monacor) (type KEY PROFITEST PRIME (Z506E)) from us first. The associated key number is printed on the inside cover of the **PROFITEST PRIME AC** test instrument. On the basis of the key blank and the key number, you then have the possibility to have a matching key manufactured by a locksmith.

5.2.6 External Signal Lamps for PROFITEST PRIME AC

Connection of signal lamps is required by DIN EN 50191/VDE 0104 and DIN EN 61557-14/VDE 0413-14.

The **SIGNAL PROFITEST PRIME AC** external signal lamp combination which is available as an accessory (Z506B) is used to secure the measuring point and must be plainly visible beyond the boundaries of the danger zone. It's connected to the socket identified with the lamp symbol  in the **HV TEST** connector panel.

Note

For safety reasons, only the Z506B signal lamp combination from GMC-I Messtechnik GmbH may be used.

Note

If the signal lamp combination has been connected incorrectly or is defective, operation of the high-voltage testing module is not possible.

Refer to section 26.8 on page 109 regarding lamp replacement

5.2.7 Emergency Off Switch for PROFITEST PRIME AC

Connection of an emergency off switch is required by DIN EN 50191/VDE 0104 and DIN EN 61557-14/VDE 0413-14.

The **STOP PROFITEST PRIME AC** external emergency off switch which is available as an accessory (Z506D) is used to secure the measuring point in the event of danger due to interruption of high-voltage to the high-voltage pistols. It's connected to the socket identified with the emergency off symbol in the **HV TEST** connector panel.

Note

For safety reasons, only the Z506D emergency off switch from GMC-I Messtechnik GmbH may be used.

Note

If the emergency off switch has been connected incorrectly or is defective, operation of the high-voltage testing module is not possible.

5.2.8 Current Clamp Sensors

The following current clamp sensors for leakage current measurement can be connected to the socket with the  symbol:

PROFITEST CLIP, Z3512A*, WZ12C*, METRAFLEX P300*

* Only with ADAPTER-Z506J-PROFITEST-PRIME (M12 angle plug to two 4 mm safety sockets)

6 Indication of Operating States for the PROFITEST PRIME AC

External Signal Lamps

The **SIGNAL PROFITEST PRIME AC** external signal lamp combination which is available as an accessory (Z506B) is used to indicate two operating states:

Green: test instrument ready for operation

- Key switch in the **ON** position.
- Supply power for the signal and control circuits of the high-voltage measuring circuit are switched on.
- Test voltage supply circuits are still switched off, and are still secured against inadvertent activation.



Attention!

All safety precautions should now have been implemented which are required for entering the danger zone, amongst others attachment of WS1 warning signs and ZS2 auxiliary signs in accordance with DIN 40008-3.



Attention!

Warning lamps (Z506B signal lamp combination) may possibly fail (for example due to damaged lamp inserts or connector cables).

Therefore, the inspector always has to ensure that no other persons are present in the potential danger zone of the test to be performed or of the DUT (e. g. by means of appropriate shutoff measures).

Red: test instrument ready for activation, **caution - danger!**

- The menu for starting the dielectric strength test has been opened, and the **ON/START** key has been activated.
- The power supply circuit for the safety test probe is still switched off, assuming the trigger has not been pulled at the high-voltage pistol.
- The test probes are secured against inadvertent contact, as long as the triggers at the high-voltage pistols have not been pulled.



Note

Without correct connection of a functional signal lamp combination, operation of the high-voltage testing module is not possible. Consequently, an automatic self-test of the signal lamps is performed whenever rotary switch position **HV** has been selected and a voltage test has been subsequently launched for the first time, see below.



Attention!

All means of access to the danger zone must be closed when the high-voltage module is "ready for activation"!

Automatic Signal Lamp Test

Whenever a voltage test is launched for the first time with the rotary switch set to position **HV**, an automatic self-test of the signal lamps is performed. The green signal lamp briefly lights up once again when the red signal lamp has already lit up.

After the lamp test has been completed successfully, the red signal lamp continues to light up and the voltage test can be performed.

If an error has occurred, the green signal lamp lights up again or none of the signal lamps lights up, respectively. The high-voltage module is not activated in this case and the voltage test cannot be launched.

Check the accessories in use and all terminals for correct connection in this case.

Please observe the notes in section 5.2, "Connecting Probes and Warning Devices to the Test Instrument", as of page 17 and in section 26, "Maintenance and Recalibration", as of page 108.

This page has been left blank intentionally.

7 Device Settings – Setup

Setup

Device parameters are selected, the database and the Bluetooth interface are configured, and the firmware version is queried in this switch position.



Currently enabled key

Key with no current function

Menu Selection for Operating Parameters

- 1 LED test
- 2 Battery test, acoustic signal and display test
- 3 Time, language, display times, GomeSetting, brightness/contrast
- 4 Device type, no., software revisions, calibration and adjustment date
- 5 Select, add or delete inspector

Display: date / time

Display: auto-shutdown of the tester after 60 s

Display: auto-shutdown of display illumination after 15 s

Display: current inspector

LED tests

- 1 Return to main menu
- MAINS NETZ LED: test green
- MAINS NETZ LED: test red
- BATT LED: test green
- BATT LED: test red

LCD and acoustic signal tests

- No function
- No function
- No function
- UL/RL LED: test red
- RCD FI LED: test red

Bluetooth® plus Brightness and Contrast Settings

- 3 Return to main menu
- No function
- Bluetooth® → **3h**
- DB mode (database display) → **3g**
- Brightness/contrast → **3f**

Time, On-Time and Default Settings

- Time → **3a**
- Date → **3a**
- Language for user interface → **3b**
- No function **3c**
- Duty cycle for display illumination / tester **3d**
- Default settings → **3e**

3d Display Illumination On-time

- Return to submenu
- 10 s
- 15 s
- 20 s
- 30 s

Test Instrument On-Time

- 30 s
- 60 s
- 120 s
- 5 min
- >>>>
- No automatic shutdown, continuously on

Menu Selection for Operating Parameters

						LED test
Display: date / time		03:29:09	02.02.2017			Battery test, acoustic signal and display test
Display: auto- shutdown of the tester after 60 s		LCD on	60 s			Time, language, display times, GameSetting, brightness/contrast
Display: auto- shutdown of display illumination after 15 s		LCD on	15s			Device type, no., software revisions, calibration and adjustment date
Display: current inspector		TESTER				Select, add or delete inspector

Bluetooth® plus Brightness and Contrast Settings

3	Return to main menu				Time →	3a
	No function		02:36:59	02.02.2017	Date →	
	Bluetooth® →			DE	Language for user interface →	3b
	DB mode (database display) →			on	No function	3c
	Brightness/contrast →			SETTING	Duty cycle for display illumination / tester	3d
					Default settings →	3e

Set Time, Language, Profiles, Acoustic Signal

3a	Return to submenu			02:36:43	02.02.2017	Set time
	Decrease hours		02:36:43	02:36:43	02:36:43	Accept settings
	Decrease minutes		02:36:43	02:36:43	02:36:43	Increase hours
	Decrease seconds		02:36:43	02:36:43	02:36:43	Increase minutes
			02:36:43	02:36:43	02:36:43	Increase seconds

Set time

3a	Return to submenu			02:36:43	02.02.2017	Set date
	Decrease day		02.02.2017	02.02.2017	02.02.2017	Accept settings
	Decrease month		02.02.2017	02.02.2017	02.02.2017	Increase day
	Decrease year		02.02.2017	02.02.2017	02.02.2017	Increase month
			02.02.2017	02.02.2017	02.02.2017	Increase year

Set date

Significance of Individual Parameters

1 LED test

The LEDs on the test instrument and their various statuses can be checked here (red or green).

Beyond this, testing of the three key functions (measurement, trigger and save key) can be tested here for I-SK4 or I-SK12 probes (optional accessories).



2 Battery Test, Acoustic Signal and Display Test

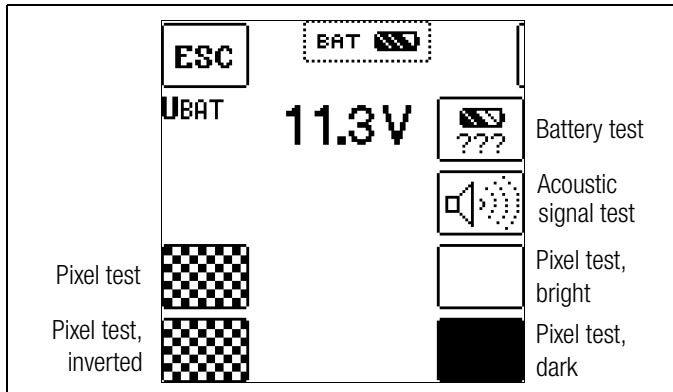

Submenu: Battery Level Query

If battery voltage has dropped to 9.6 V or less, the **UL/RL LED** lights up red and an acoustic signal is generated as well.

Note

Measuring Procedure

If battery voltage drops to below 9.6 V during a measuring procedure, this is indicated by means of a popup window as well as an acoustic signal. Measured values are invalid. The measurement results cannot be saved to memory.



➔ Press **ESC** in order to return to the main menu.

3 Time/Date, User Language, Shutdown Times, Default Settings, Brightness/Contrast, Database Mode, Bluetooth



Attention!

Data loss after restoring default settings!

Back up your structures, measurement data and sequences to a PC before pressing the respective key. The prompt window shown at the right asks you to confirm deletion.



3a Time and Date Settings

See page 21 for settings.



3b User Interface Language (CULTURE)

➔ Select the desired country setup with the appropriate country code.



3c No Function

3d Test Instrument / Display Illumination On-Time

The period of time after which the test instrument and LCD illumination are automatically shut off can be selected here. This selection has a considerable influence on the service life and the charging status of the batteries.

3d Display Illumination On-Time

The period of time after which LCD illumination is automatically shut off can be selected here. This selection has a considerable influence on the service life and the charging status of the batteries.

3e Default Settings (GOME SETTING)

The test instrument is returned to its original default settings when this key is activated.



3f Adjusting Brightness and Contrast

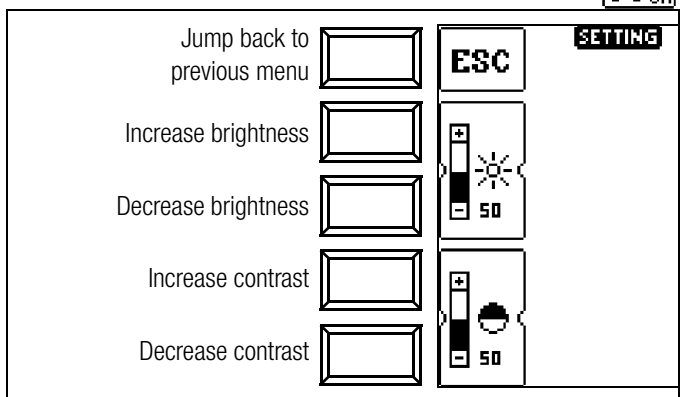

3g DB-MODE – Display of the Database in the Text or ID Mode

Creating Structures in the TXT MODE

The database in the test instrument is set to the text mode as a default feature and "TXT" appears in the header. You can create structure elements in the test instrument and label them in plain text, e.g. Customer XY, Distributor XY and Circuit XY.

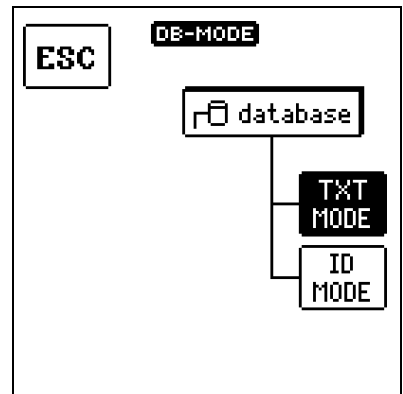

Creating Structures in the ID MODE

You can work in the ID MODE as an alternative, in which case "ID" appears in the header. You can create structure elements in the test instrument and label them with any desired ID numbers.

Note

Structures can be created in the test instrument in either the text mode or the ID mode.

In contrast to this, designations and ID numbers are always assigned in the report generating program.

If no texts or ID numbers have been entered to the test instrument when creating structures, the report generating program creates the missing entries automatically. These can then be edited in the report generating program and transferred back to the test instrument if required.

3h Switching Bluetooth® On/Off

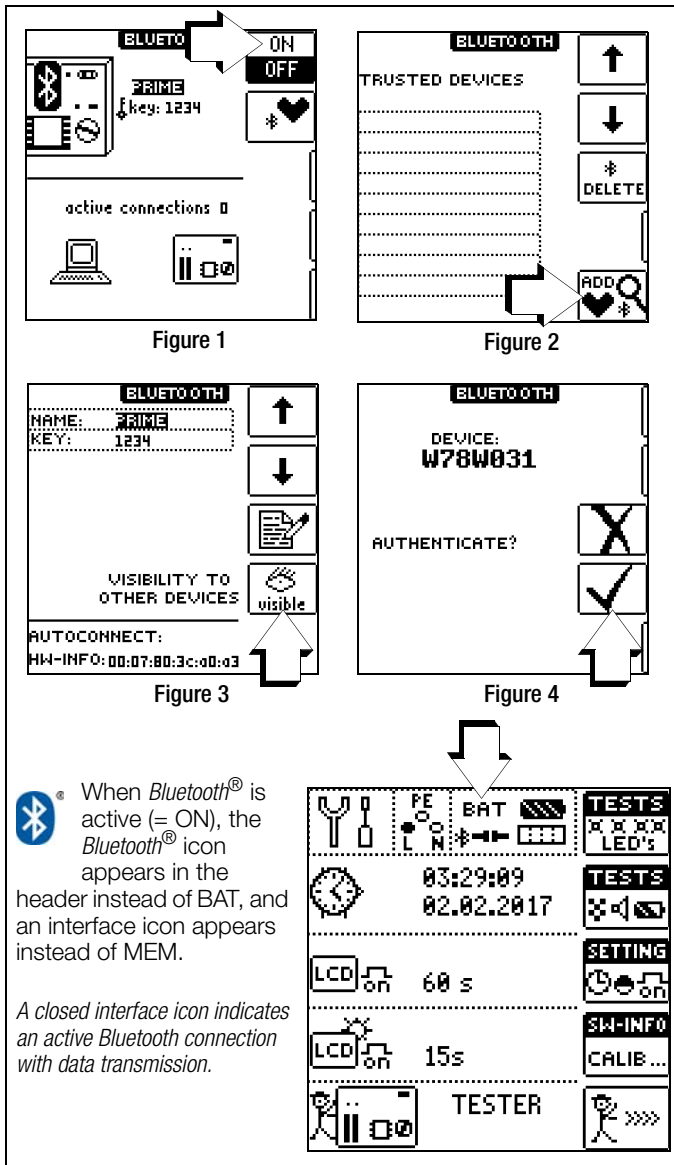

When Bluetooth® is active (= ON), the Bluetooth® icon appears in the header instead of BAT, and an interface icon appears instead of MEM.

A closed interface icon indicates an active Bluetooth connection with data transmission.

If your PC is equipped with a Bluetooth® interface, wireless communication is possible between the test instrument and the report generating program for the transfer of data and test structures. One-time only authentication of the respective PC with the test instrument is a prerequisite for wireless data exchange. The function selector switch must be in the SETUP position to this end. Furthermore, the correct Bluetooth® COM port must also be selected in the report generating software.

Note
Only activate the Bluetooth® interface at the test instrument for data transmission, or for entering text via the Bluetooth® keyboard. Interface power consumption reduces battery service life when activated continuously.

If several test instruments are within range during authentication, the respective name should be changed in order to rule out the possibility of a mix-up. Blanks may not be used. The default PIN, namely "1234", can be changed, but this is unnecessary as a rule. As shown in figure 3, the test instrument's MAC address is displayed in the footer as **hardware information**.

Make your test instrument visible prior to authentication, and subsequently invisible for security reasons.

Steps Required for Authentication

Make sure that the test instrument is within range of the PC (roughly 5 to 8 meters). Activate Bluetooth® at the test instrument (see figure 1) and at your PC.

The function selector switch must be in the SETUP position to this end.

Make sure that the test instrument (see figure 3) and your PC are visible for other Bluetooth® devices:

The word **visible** must be displayed at the test instrument underneath the eye symbol.

Use your Bluetooth® PC driver software to add a new Bluetooth® device. In most cases, this is accomplished with the help of the "Add new connection" or "Add Bluetooth® device" button.

The following steps may vary, depending on which Bluetooth® PC driver software is used. Basically, a PIN must be entered at the PC. The default setting for the PIN is "1234", and is displayed in the main Bluetooth® menu (see figure 1) at the test instrument. Subsequently, or previously, an authentication message must be acknowledged at the test instrument (see figure 4).

If authentication has been successful, a corresponding message appears at the test instrument. Furthermore, the authenticated PC is displayed in the "Trusted Devices" menu at the test instrument (see figure 2).

The PROFITEST PRIME should now also be listed as a device in your Bluetooth® PC driver software. Further information is also provided here regarding the utilized COM port. With the help of your Bluetooth® PC driver software, you'll need to find out which COM port is used for the Bluetooth® connection. This port is frequently displayed after authentication, but if this is not the case this information can be found in your Bluetooth® PC driver software.

The report generating program includes a function for automatically ascertaining the utilized COM port after successful authentication has been completed.

If the test instrument is within range of your PC (5 to 8 meters), wireless data exchange can now be initiated with the help of the report generating program by clicking Bluetooth® in the "Extras" menu. The number of the correct COM port (e.g. COM40) must be entered to the report generating software when data exchange is started.

Alternatively, the COM port number can be selected automatically by clicking the "Find Bluetooth Device" item in the menu.

Connecting a Bluetooth® Keyboard

Observe the steps required for authentication when connecting a Bluetooth® keyboard (see above section).

Attention!
Activate the required keyboard signal in order to pair the Bluetooth® keyboard.

Note
After first successful pairing, the Bluetooth® keyboard always activates itself automatically.

We recommend the use of Bluetooth® keyboards from Logitech®. We can make no guarantees for other devices.

4 Device Type, No., Software Revisions, Calibration and Adjustment Date (Example)



⇒ Press any key in order to return to the main menu.

SW-INFO	
TYPE	M506C
S/NO	AK5554710009
SW1 01.02.00	HW1 A01
SW2 REV 8015	HW2 48.10.1
SW3 REV 1450	HW3 49.10.1
SW4 4.20.2	HW4 50.10.1
SW5 1.171.3	HW5 65535.655
CAL.-DATE	19.11.2017
ADJ.-DATE	19.11.2017

Firmware Update:

The layout of the test instruments makes it possible to adapt device software to the latest standards and regulations. Beyond this, suggestions from customers result in continuous improvement of the test instrument software, as well as new functions. In order to assure that you can take advantage of all of these benefits without delay, you can quickly and completely update your test instrument software on-site (see section 26.11).

5 Selecting, Adding or Deleting an Inspector



Add a new inspector

- Select letter/character
- Select letter/character
- Accept letter/character
- ? Accept name
- Delete letter/character
- Shift: upper/lowercase letters, vowel mutations, special chars.

See also section 8.5 on page 27 regarding the entry of a text.

- Select inspector
- Select inspector
- Accept inspector
- Delete inspector

8 General Notes

8.1 Automatic Settings, Monitoring and Shut-Off

The test instrument automatically selects all operating conditions which it's capable of determining itself. It tests line voltage and frequency. If these lie within their valid nominal ranges, they appear at the display panel. If they're not within nominal ranges, prevailing voltage (U) and frequency (f) are displayed instead of U_N and f_N .

Touch voltage which is induced by test current is monitored for each measuring sequence. If touch voltage exceeds the selected limit value, measurement is immediately interrupted. The **UL/RL LED** lights up red.

If **battery voltage** falls below the allowable limit value the instrument cannot be switched on, or it is immediately switched off.

The measurement is interrupted automatically, or the measuring sequence is blocked (except for voltage measuring ranges and phase sequence testing) in the event of:

- Impermissible line voltages (< 60 V, > 253 V / > 330 V / > 440 V or > 725 V) for measurements which require line voltage
- Interference voltage during insulation resistance or low resistance measurements
- Interference voltage during a high-voltage measurement (**PROFITEST PRIME AC**)
- Overheating of the instrument

As a rule, excessive temperatures only occur after approximately 50 measurement sequences at intervals of 5 seconds, when the rotary selector switch is set to the **ZLOOP** position. If an attempt is made to start a measuring sequence, an appropriate message appears at the display panel.

The instrument only switches itself off automatically after completion of an automatic measuring sequence, and after the predetermined on-time has expired (see page 22). On-time is reset to its original value as defined in the setup menu, as soon as any key or the rotary selector switch is activated.

The instrument remains on for approximately 75 s in addition to the preset on-time for measurements with rising residual current in systems with selective RCDs.

The instrument always shuts itself off automatically!

8.2 Measured Value Display and Memory

The following items appear at the display panel:

- Measured values with abbreviations and units of measure
- Selected function
- Nominal voltage
- Nominal frequency
- Error messages

Measurement values for automatic measuring sequences are stored and displayed as digital values until the next measurement sequence is started, or until automatic shutdown occurs.

If the upper range limit is exceeded, the upper limit value is displayed and is preceded by the ">" symbol (greater than), which indicates measurement value overrun.



Note

The depiction of LEDs in these operating instructions may vary from the LEDs on the actual instrument due to product improvements.



Note

See also "Functionality of the Probes, Indication by Means of LEDs and LCD Symbols" as of page 91.



Attention!

Reversal of N and PE in a system without RCCBs cannot be detected and is not indicated by the instrument. In a system including an RCCB, the RCCB is tripped during "touch voltage measurement without RCCB tripping" (automatic ZLOOP measurement), if N and PE are reversed.

8.3 Help Function

The following information can be displayed for each switch position and basic function **after it has been selected with the rotary selector switch**:

- Wiring diagram
- Measuring range
- Nominal range of use and measuring uncertainty
- Nominal value



• Measurement of $U_{I\Delta N}$ and R_E with $I_{\Delta N}$, without tripping of RCD.
 • $U_{I\Delta N}$ - and R_E -Measure: Press **START**
 • Subsequently, trip RCD: Press **$I_{\Delta N}$**

- Press the **HELP** key in order to query online help.
- If several pages of help are available for the respective measuring function, the **HELP** key must be pressed repeatedly.
- Press the **ESC** key in order to exit online help.

8.4 Setting Parameters or Limit Values using RCD Measurement as an Example

- 1 Access the submenu for setting the desired parameter.
- 2 Select a parameter using the \uparrow or \downarrow scroll key.
- 3 Switch to the setting menu for the selected parameter with the \rightarrow scroll key.
- 4 Select a setting value using the \uparrow or \downarrow scroll key.
- 5 Acknowledge the setting value with the \downarrow key. This value is transferred to the settings menu.
- 6 The setting value is not permanently accepted for the respective measurement until \checkmark is pressed, after which the display is returned to the main menu. You can return to the main menu by pressing ESC instead of \checkmark , without accepting the newly selected value.

Parameter Lock (plausibility check)

Individually selected parameter settings are checked for plausibility before transfer to the measurement window.



If you select a parameter setting which doesn't make sense in combination with other parameter settings which have already been entered, it's not accepted. The previously selected parameter setting remains unchanged.

Remedy: Select another parameter setting.

8.5 Freely Selectable Parameter Settings or Limit Values



8.5.1 Changing Existing Parameters

Individual parameters can be changed for certain measuring functions, i.e. adjusted within predetermined limits.

The **EDIT** menu  doesn't appear until after switching to the right-hand column and selecting the editable parameter .

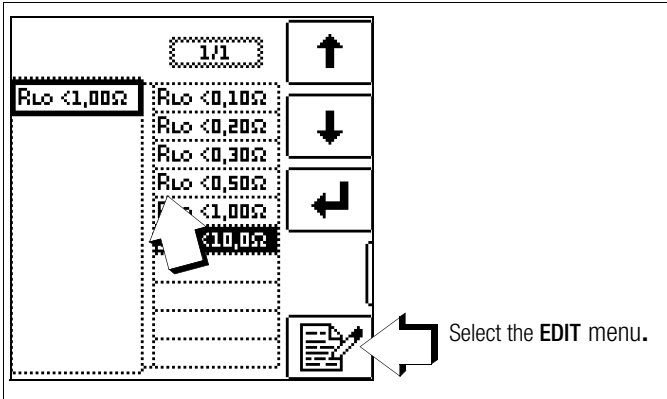
Example for RLO Measuring Function, Parameter: LIMIT RLO



- 1 Open the submenu for setting the desired parameter (no figure, see section 8.4).
- 2 Select the editable parameter (identified with the  icon) with the \uparrow or \downarrow scroll key.
- 3 Select the edit menu by pressing the  key.

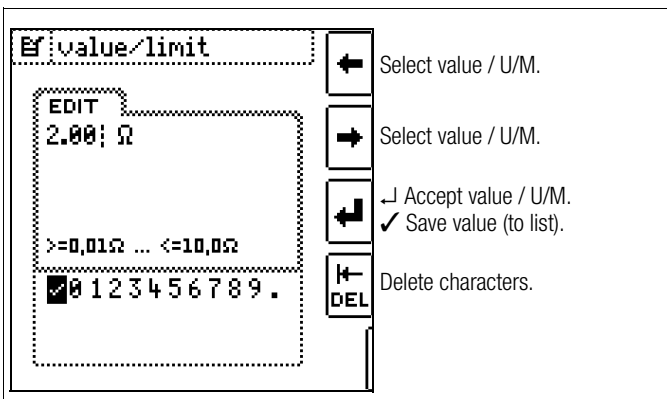

- 4 Select the respective characters with the left or right cursor key. The character is accepted by pressing the \downarrow key. The value is acknowledged by selecting \checkmark and then pressing the \downarrow key.

Note

Observe the predefined limits for the new setting value. Enter any places to the right of the decimal point as well.

8.5.2 Adding New Parameters

For certain measuring functions, additional values within predefined limits can be added in addition to the fixed values.

The **EDIT+** menu  doesn't appear until after switching to the right-hand column.

Example for HV-AC Measuring Function – Parameter: LIMIT IUM

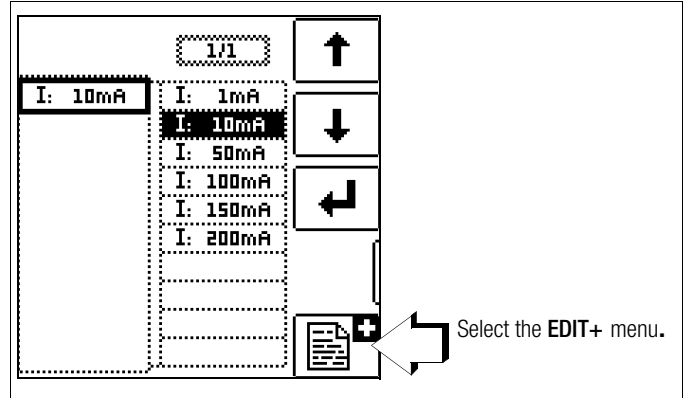

- 1 Open the submenu for setting the desired parameter (no figure, see section 8.4).
- 2 Select the edit menu by pressing the  key.

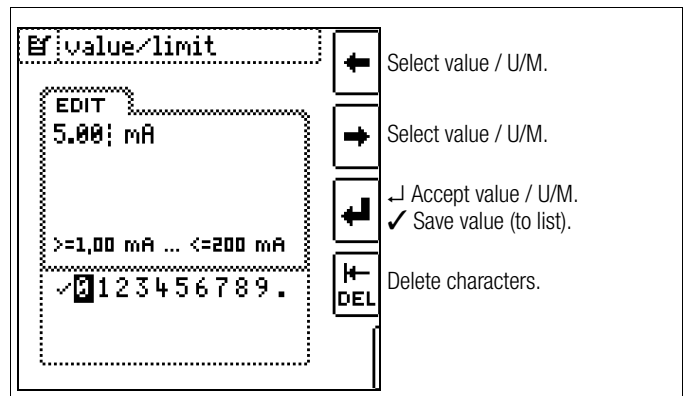

- 3 Select the respective characters with the left or right cursor key. The character is accepted by pressing the \downarrow key. The value is acknowledged by selecting \checkmark and then pressing the \downarrow key. The new parameter is added to the list.

Note

Observe the predefined limits for the new setting value. Enter any places to the right of the decimal point as well.

8.6 2-Pole Measurement with Fast or Semiautomatic Polarity Reversal

Fast, semiautomatic polarity reversal is possible for the following measurements:

- Voltage measurement **U**
No device-internal polarity reversal takes place – the display is only for the purpose of documentation.
- Loop impedance measurement **ZLOOP**
- Insulation resistance measurement **RISO**
- Dielectric strength test **HV AC (PROFITEST PRIME AC only)**

Fast Polarity Reversal

The polarity parameter is set to **AUTO**.

Fast and convenient switching amongst all polarity variants without switching to the parameter settings submenu is possible by pressing the Δ_N key at the instrument or on the optional I-SK4/12-PROFITEST PRIME probe (Z506T/U).

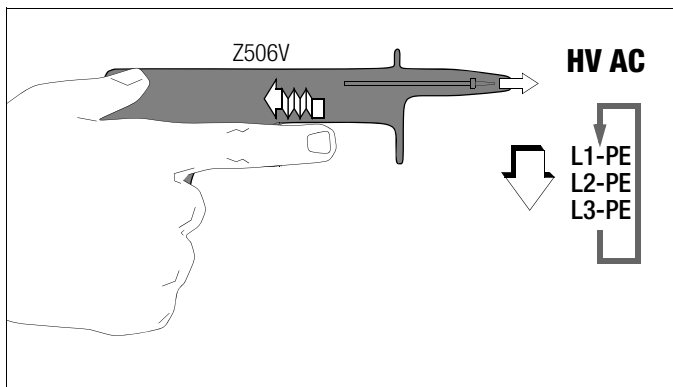
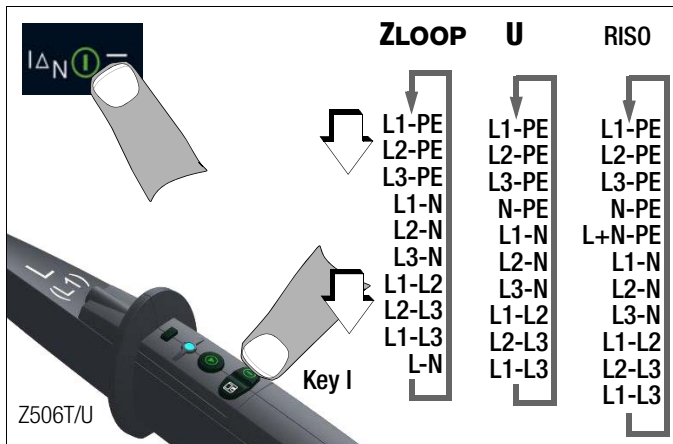
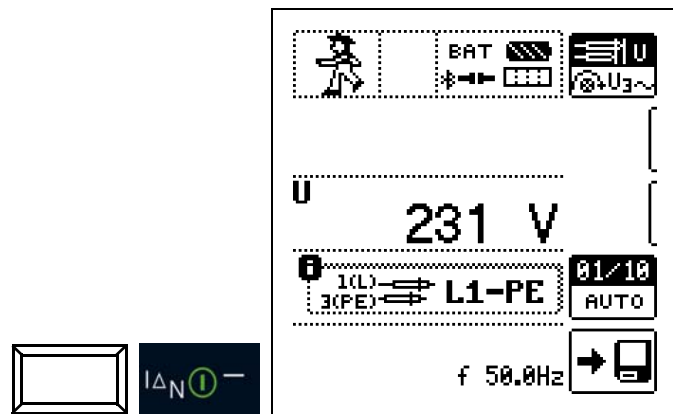

Semiautomatic Polarity Reversal in Memory Mode

The polarity parameter is set to **AUTO**.

If testing is to be conducted with all polarity variants, automatic polarity switching takes place after each measurement after **saving**.

Polarity variants can be skipped by pressing the Δ_N key at the instrument or on the optional I-SK4/12 probe.

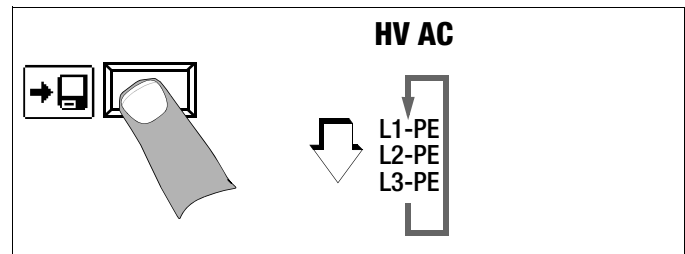
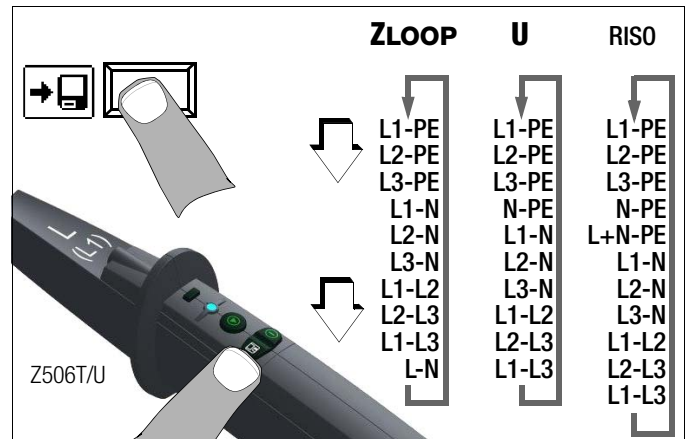

Note

The I-SK4 and I-SK12 (Z506T/U) test probes are available as optional accessories.

9 U – Measuring Voltage and Frequency

Select the measuring function:



The **U** measuring function offers the opportunity of measuring direct voltage, as well as alternating voltage and its associated frequency.

It's subdivided into two views:

- **U**: 2-pole measurement of voltage and frequency
- **U3~**: Measurement of voltage and frequency in 3-phase systems including phase sequence testing

Selection is made by pressing one of the softkeys shown at the right. The momentary selection is displayed inversely (white on black).



9.1 U

9.1.1 General

Direct and alternating voltage can be measured in a single-phase system in the "2-pole" view.

9.1.2 Help Function

Illustrations showing how to connect the probes and measurement instructions can be displayed by pressing the **HELP** key. The help function is exited by pressing the **ESC** key.

9.1.3 Parameters

Conductor Relationship

This parameter serves the purpose of documentation. No device-internal polarity reversal takes place.

The specification of conductor relationship points makes it possible to allocate measured values and measuring points to each other. Selection can be made between:

- **Manual**: The measured value is saved for the selected measuring point only.
- **AUTO**: The user can switch through all available measuring points by pressing the $I\Delta_N$ key. Measured values are saved for the momentary setting.



9.1.4 U Measurement

Connection

Probe 1(L)
Probe 3(PE)

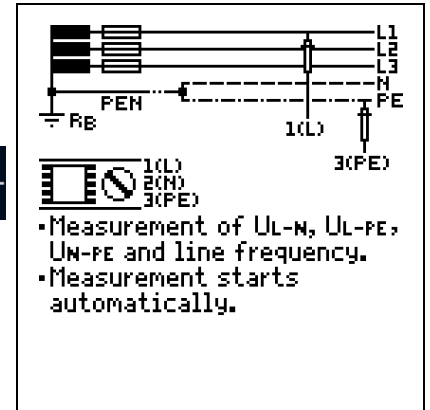

Measurement

Measurement is continuously active, i.e. measurement takes place directly without pressing the **ON/START** key.

Corresponding report generation is possible after measurement has been completed by pressing the save button (softkey).



Voltage Polarity

If the installation of single-pole switches to the neutral conductor is prohibited by the standards, voltage polarity must be tested in order to assure that all existing single-pole switches are installed to the phase conductors.



Note

The protective caps on the test probes can be removed for measurements at 4 mm sockets. This results in downgrading to CAT II.

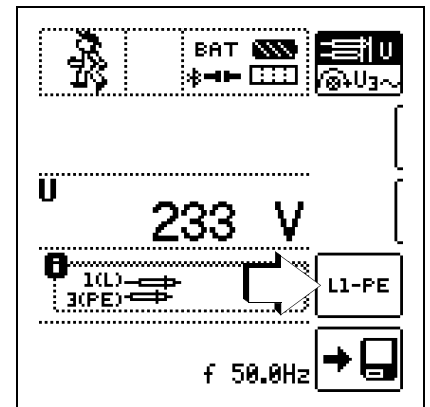

9.2 U3~

9.2.1 General

If "U3~" is selected via softkey, voltage, frequency and phase sequence can be measured in 3-phase systems.



9.2.2 Help Function

Illustrations showing how to connect the probes and measurement instructions can be displayed by pressing the **HELP** key. The help function is exited by pressing the **ESC** key.

9.2.3 U3~ Measurement

Connection

L1: probe 1(L)
L3: probe 2(N)
L2: probe 3(PE)

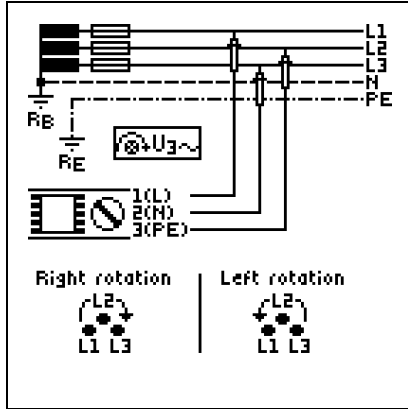

Measurement

Measurement is continuously active, i.e. measurement takes place directly without pressing the **ON/START** key.

Corresponding report generation is possible after measurement has been completed by pressing the save button (softkey).

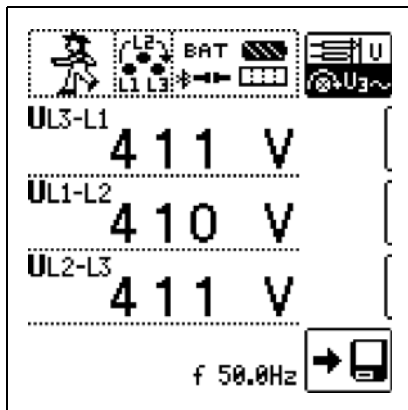

Direction of rotation is indicated by means of the following displays:



Clockwise Rotation



Counterclockwise Rotation

9.2.4 Notes:

- As a rule, clockwise rotation is required at 3-phase electrical outlets.
- Various adapters are available as accessories for measurements at CEE outlets.
- Measurement instrument connection is usually problematic with CEE outlets due to contact problems. Measurements can be executed quickly and reliably without contact problems with the help of the Z500A variable plug adapter set available from GMC.
- Connection for 3-wire measurement: L1-L2-L3 at plug in clockwise direction as of PE socket



Note

See section 24 regarding all indications for the mains connection test.

10 RLO – Measuring Low-Value Resistance

10.1 RLO 0.2A – Measuring Low-Value Resistance with 0.2 A Test Current

Select the measuring function:



10.1.1 General

In accordance with IEC 60364-6/DIN VDE 0100-600, the continuity of protective conductors (including the equipotential bonding conductor via the main grounding busbar and the additional equipotential bonding conductor) and active conductors in final ring circuits must be tested.

Measurement Principle

Continuity of conductors is ascertained by means of a constant test current and voltage drop at the device under test.



Note

If direct voltage is used as the test voltage, DIN EN 61557-4 specifies performance of the measurement with polarity reversal. And thus measurement must be performed with (automatic) polarity reversal of the measuring voltage or with the flow of current in one direction (+ pole to PE) and then the other (- pole to PE).

10.1.2 Help Function

Illustrations and measurement instructions can be displayed by pressing the **HELP** key.

After measurement has been completed, the associated cable lengths for various cable cross-sections can be displayed based on the measured value by pressing the **HELP** key.

The help function is exited by pressing the **ESC** key.

10.1.3 Parameters

Test Signal

The test signal can be selected here based on the following criteria:

- **Function:** constant or ramp
- **Polarity:** positive +, negative –, automatic polarity reversal ±

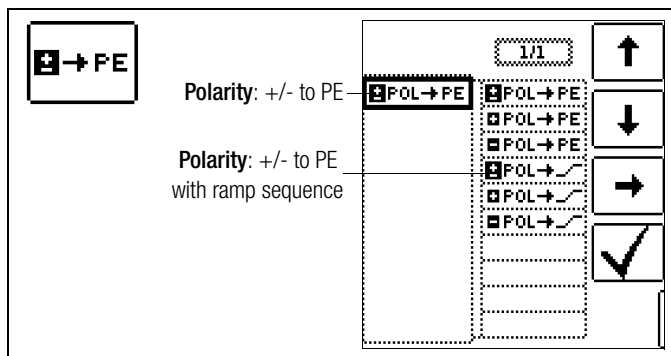

Test Duration – Measuring Times

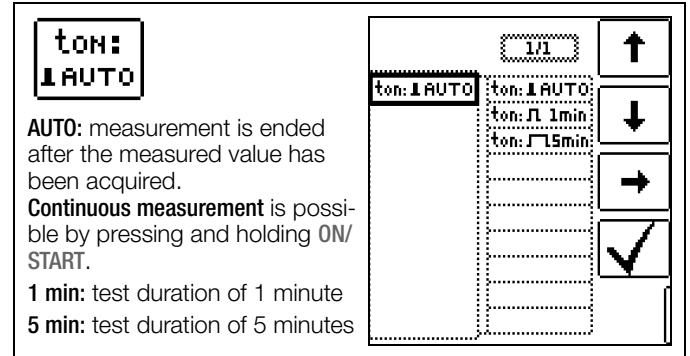

Limits – Setting the Limit Value

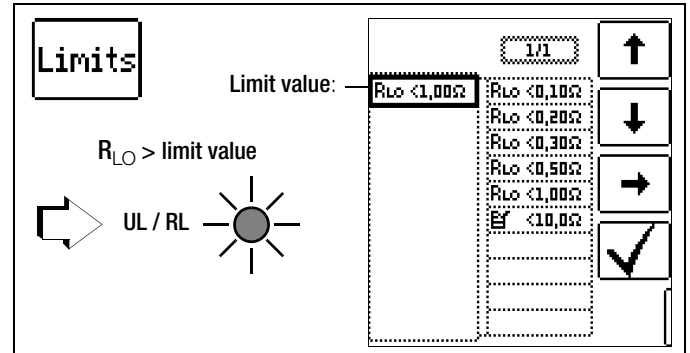

The limit value for resistance can be set as desired. If measured values occur which are above this limit value, the red UL/RL LED lights up.

Limit values can be selected within a range of 0.10 Ω to 10.0 Ω (editable). The limit value is displayed above the measured value.

10.1.4 ROFFSET Measurement



Attention!

The low-resistance measurement may only be conducted at voltage free devices under test or system components. Contact the measuring point first and then start the measurement!

Connection

Probe 1(L)
Probe 3(PE)

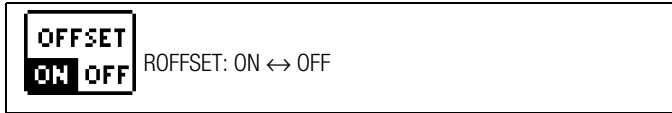
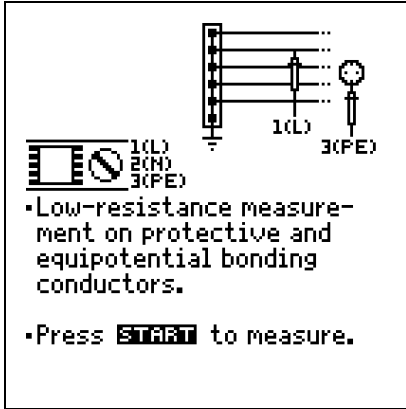

Measuring ROFFSET

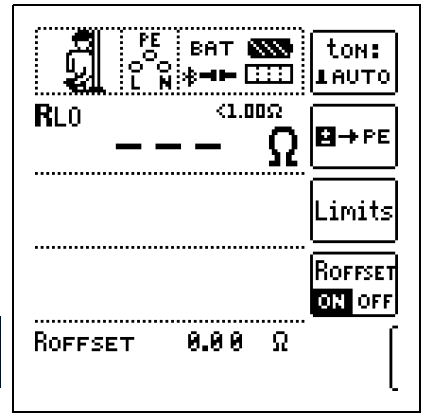

The following must be observed:

- The acquired **ROFFSET** value is deleted when the test signal is changed or if the function is deactivated.
- If an error message appears, the last acquired, valid value is retained.
- As a result of the utilized 4-wire technology, resistance of the probe cables does not have to be calculated into the measurement results.



Note

Extension Cords

Only use this function when working with extension cables. When different extension cables are used, the above described procedure must always be repeated.

Compensation for Measurement Cables up to 10 Ω

The **ROFFSET** function provides the user with the opportunity of deducting the resistance of extension cords in advance which are used in addition to the probe cables, in order to avoid distorted measurements.

This value is deducted from the measurement result.

ROFFSET Measurement Description

- ⇨ Activate the **ROFFSET** function by pressing the corresponding softkey.
- ⇨ **ROFFSET** = 0.00Ω is displayed.
- ⇨ Select the test signal with which you intend to conduct the measurement.
- ⇨ Then short circuit the measurement cables.
- ⇨ Start measurement by pressing the $I\Delta_N$ key.
- ⇨ An intermittent acoustic signal is generated and the message shown at the right is displayed.
- ⇨ The measuring procedure is started by once again pressing the $I\Delta_N$ key.

The procedure can be aborted by pressing **ON/START** or **ESC**.



Note

If offset measurement is stopped upon appearance of a pop-up error window (Roffset > 10 Ω or difference between RLO+ and RLO– greater than 10%), the last measured offset value is retained. Inadvertent deletion of a previously ascertained offset value is thus practically ruled out! The respectively smaller value is otherwise stored to memory as an offset value. The maximum offset value is 10.0 Ω. Negative resistances may result due to the offset value.

10.1.5 RLO 0.2 A Measurement



Attention!

The low-resistance measurement may only be conducted at voltage free devices under test or system components. Contact the measuring point first and then start the measurement!



Attention!

Measurement results may be distorted due to parallel connected impedances and equalizing current.

Start the measurement.



Press and hold for long-term measurement.

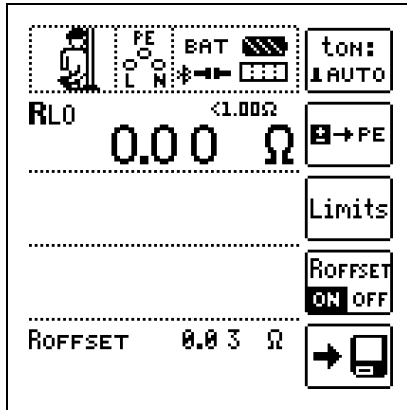

- Save: possible via softkey after successful measurement



Attention!

The test probes should always be in contact with the DUT before the start key ▼ is activated.
 If the object is energized, measurement is disabled as soon as it's contacted with the test probes.
 If the start key ▼ is pressed first and the test object is contacted with the test probes afterwards, the device fuse blows.

Automatic Polarity Reversal

After the measuring sequence has been started, the instrument performs measurement with automatic polarity reversal – first with current flow in one direction, and then in the other. In the case of long-term measurement (press and hold the ON/START key), polarity is switched once per second.

If the difference between RLO+ and RLO- is greater than 10% with automatic polarity reversal, RLO+ and RLO- values are displayed instead of RLO. The respectively larger value, RLO+ or RLO-, appears at the top and is saved to the database as the RLO value.

The measured values are displayed after test time has elapsed in accordance with the following table:

Polarity Selection	Display	Condition
+ pole to PE	RLO+	None
- pole to PE	RLO-	None
± pole to PE	RLO	Where $\Delta RLO \leq 10\%$
	RLO+ RLO-	Where $\Delta RLO > 10\%$

All four values are always saved: Rlo, Rlo+, Rlo- and Roffset.

Evaluating Measurement Results

Differing results for measurements in both directions indicate voltage at the DUT (e.g. thermovoltages or unit voltages).

Measurement results can be distorted by parallel connected impedances in load current circuits and by equalizing current, especially in systems which make use of "overcurrent protection

devices" (previous neutralization) without an isolated protective conductor. Resistances which change during measurement (e.g. inductance), or a defective contact, can also cause distorted measurements (double display).

In order to assure unambiguous measurement results, causes of error must be located and eliminated.

In order to find the cause of the measuring error, measure resistance in both current flow directions.

The instrument's batteries are exposed to excessive stress during insulation resistance measurement. For measurement with current flow in one direction, only press and hold the ON/START ▼ key as long as is necessary for the measurement.



Note

Measuring Low-Value Resistance

Measurement cable and 2-pole measuring adapter resistance is compensated for automatically thanks to the four conductor method and do not effect measurement results.

However, if an extension cord is used its resistance must be measured and deducted from the measurement results.

Resistances which do not demonstrate a stable value until after a "settling in period" should not be measured with automatic polarity reversal, but rather one after the other with positive and negative polarity.

Examples of resistances whose values may change during measurement include:

- Incandescent lamp resistance, whose values change due to warming caused by test current
- Resistances with a great conductive component
- Contact resistance
- Line reactors

Calculation of Cable Lengths for Common Copper Conductors

If the HELP key is activated after performance of resistance measurement, the cable lengths corresponding to common conductor cross-sections are displayed.



RLO: 0.16 Ω			
∅	l	∅	l
[mm²]	[m]	[mm²]	[m]
0.14:	1	2.5:	20
0.25:	2	4.0:	32
0.50:	4	6.0:	48
0.75:	6	10.0:	80
1.00:	8	16.0:	127
1.50:	12	25.0:	199

If results vary for the two different current flow directions, cable length is not displayed. In this case, capacitive or inductive components are apparently present which would distort the calculation.

This table only applies to cables made with commercially available copper conductors and cannot be used for other materials (e. g. aluminum)!

10.1.6 Evaluation of Measured Values

See tables in section 27.1.

10.1.7 RLO 0.2A Measurement at PRCDs

Applications

Protective conductor current is monitored for certain types of PRCDs. Direct activation or deactivation of the test current required for protective conductor resistance measurements of at least 200 mA results in tripping of the PRCD and thus to interruption of the protective conductor connection. Protective conductor measurement is no longer possible in this case.

A special ramp sequence for test current activation or deactivation in combination with the **PROFITEST PRCD** test adapter permits protective conductor resistance measurement without tripping the PRCD.

Measuring Procedure

- Connection: Refer to the operating instructions for the **PROFITEST PRCD** adapter.
- Parameters: Select the ramp sequence and the limit value.
- Activate the PRCD.
- ROFFSET measurement: see section 10.1.4.
- RLO 0.2A measurement: press **ON/START** (see also section 10.1.5).
- Save: possible via softkey after successful measurement



Note

Poor contacting with the test probes results in fluctuating test current and leads to interruption of the measurement and display of the popup message shown at the right.



Ramp Function Time Sequence

Due to the physical characteristics of the PRCD, **measuring times** for this ramp function amount to several seconds.

If test current polarity is reversed, additional **waiting time** is also required during polarity reversal.

This is programmed into the test sequence in the “automatic polarity reversal” operating mode.

Revers polarity manually, e.g. from “+pole with ramp” to “-pole with ramp” . The test instrument then detects the reversal of current flow direction, stops measurement for the required waiting time and simultaneously displays a corresponding message (see figure at right).

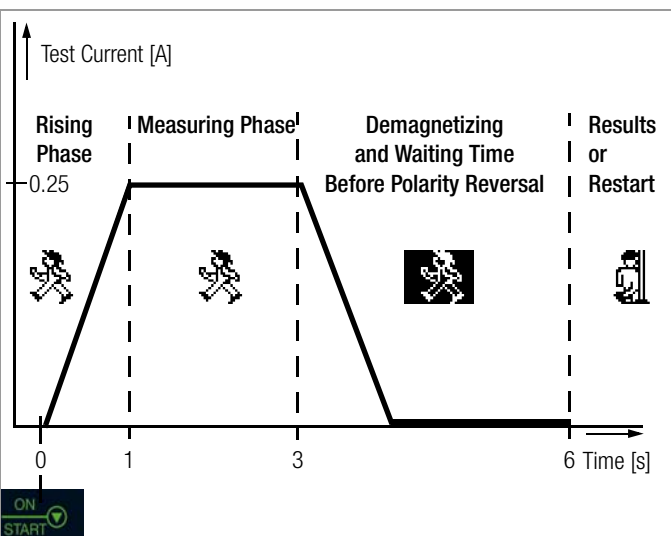
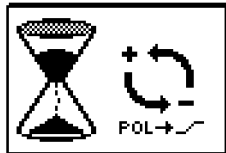

Representation of Measuring and Waiting Times for Protective Conductor Resistance Measurement at PRCDs with the PROFITEST PRIME

PRCD Tripping due to Poor Contacting

Good contact must be assured between the test probes and the device under test or the sockets at the **PROFITEST PRCD** test adapter during measurement. Interruptions can result in considerable test current fluctuation which causes the PRCD to trip under unfavorable conditions.

If this is the case, tripping of the PRCD is automatically detected by the test instrument and indicated by a corresponding error message (see figure at the right). In this case as well, the test instrument automatically takes subsequently required waiting time into account before you can reactivate the PRCD and start the measurement over again.



Connection

- Read the operating instructions for the **PROFITEST PRCD** adapter, in particular section 4.1. It includes connection instructions for offset measurement and for protective conductor resistance measurement.

Selecting the Polarity Parameter

- Select the desired polarity parameter with ramp.



Measuring ROFFSET

- Perform offset measurement as described in section 10.1.4, in order to assure that the test adapter’s connector contacts are not included in the measurement results.

Measuring Protective Conductor Resistance

- Determine whether or not the PRCD is activated. If not, activate it.
- Perform protective conductor measurement as described in section 10.1.5 above. Start the test sequence by briefly pressing the **ON/START** key. The predetermined duration of the measuring phase can be extended by pressing and holding the **ON/START** key.



Attention!

The low-resistance measurement may only be conducted at voltage free devices under test or system components. Use the **PROFITEST PRCD** test adapter (M512R) for testing PRCDs after carefully reading the operating instructions.

Start the measurement.

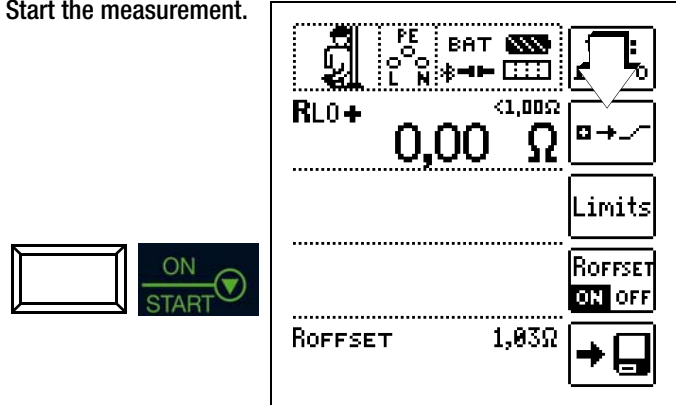

The symbol shown at the right appears during the magnetization phase (rising curve) and the subsequent measuring phase (constant current).



If measurement is aborted already during the rising phase, no measurement results can be ascertained or displayed.

After measurement, the demagnetization phase (falling curve) and subsequent waiting time are indicated by the inverted symbol shown at the right. No new measurements can be started during this time.



Measurement results cannot be read and measurement with the same or another polarity cannot be started until the symbol at the right appears.



10.2 RLO 25A – Measuring Low-Value Resistance with 25 A Test Current

Select the measuring function:



10.2.1 Measurement Principle

Continuity of protective conductor systems is determined by applying a test current with line frequency and measuring the resultant voltage drop.

Testing must be conducted between the PE terminal and various points within the protective conductor system.

Due to the high amperage of the utilized test current, this type of measurement is above all suitable for precise continuity testing of especially low-resistance protective conductor systems, i.e. in the case of large cross-sections and/or short cable lengths.

This type of measurement necessitates mains auxiliary power and the mains switch must be set to the ON position.

Mains auxiliary power is checked to make sure it's right before measurement is started. Permissible line voltages are 115 and 230 V, and permissible line frequencies are 50 and 60 Hz.

10.2.2 Help Function

Illustrations and measurement instructions can be displayed by pressing the **HELP** key.

After measurement has been completed, the associated cable lengths for various cable cross-sections can be displayed based on the measured value by pressing the **HELP** key.

The help function is exited by pressing the **ESC** key.

The measurement is aborted if voltage is present at the test probes when measurement is started.* A corresponding error message appears at the display.

* This warning might also appear if continuity of the protective conductor connection is impaired, because in this case external voltages have been capacitively induced.

10.2.3 Parameters

Limits – Low-Resistance Limit Value

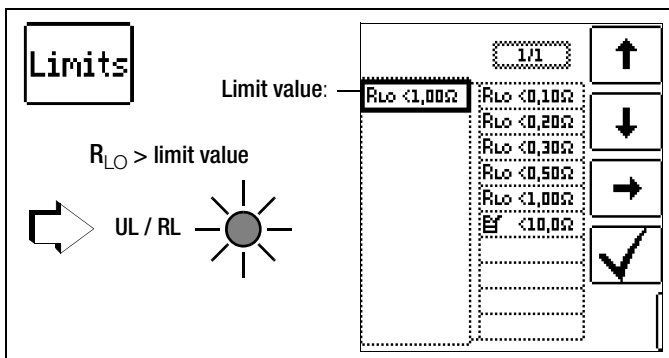

The limit value of the conductor under test is configured here. This setting depends on conductor cross-section.

Selection can be made between preset parameters or an adjustable value within a range of 0 to 10 Ω .

If the limit value is exceeded, the **UL/RL LED** lights up red.

10.2.4 ROFFSET Measurement

The **ROFFSET** function provides the user with the opportunity of deducting the resistance of extension cords in advance which are used in addition to the probe cables, in order to avoid distorted measurements.

This value is deducted from the measurement result.

ROFFSET Measurement Description

➤ Activate the **ROFFSET** function by pressing the corresponding softkey.



➤ **ROFFSET = 0.00 Ohm** is displayed.

➤ Select the test signal with which you intend to conduct the measurement.

➤ Then short circuit the measurement cables.

➤ Start measurement by pressing the **I Δ N** key.

➤ An intermittent acoustic signal is generated and the message shown at the right is displayed.

➤ The measuring procedure is started by once again pressing the **I Δ N** key.

The procedure can be aborted by pressing **ON/START** or **ESC**.

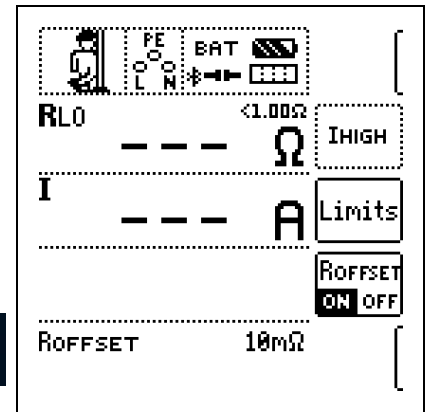
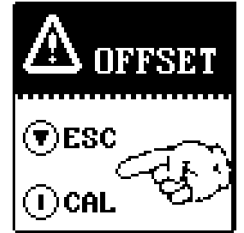

Test Duration – Measuring Times

Test duration is limited to 10 s. Use for intended purpose specifies a test duration of no more than 10 seconds and a pause of at least 30 seconds. If this repetition rate is exceeded, the instrument may overheat in which case the measurement is disabled.

10.2.5 RLo 25A Measurement

Connection

Probe 1(L)
Probe 3(PE)



Note

This type of measurement necessitates **mains auxiliary power** and the mains switch must be set to the **ON "1"** position.



Attention!

Measurements may **only be performed at voltage-free** system components.



Attention!

Be sure to fully extend the **measurement cables** before performing protective conductor testing. The measurement cables may not be rolled up.



Attention!

Measurement results may be distorted due to parallel connected impedances and equalizing current.

Measuring Procedure

- ⇨ Set the parameters.
- ⇨ Connect the probes.
- ⇨ Press the **ON/START** key.
- Test current is applied.
- Measurement is ended as soon as the measured value is stable or after 10 seconds.

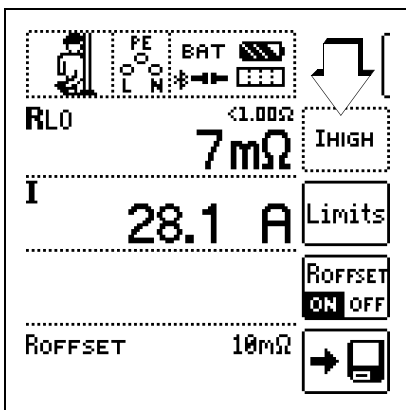

The following measured values are displayed:

RLO: Resistance
I: Test current

- ⇨ **Save:** possible via softkey after successful measurement.
- ⇨ **Determination of cable length:** press the "HELP" key.

Calculation of Cable Lengths for Common Copper Conductors

If the **HELP** key is activated after performance of resistance measurement, the cable lengths corresponding to common conductor cross-sections are displayed.



RLO: 0.16 Ω

\varnothing	l	\varnothing	l
[mm ²]	[m]	[mm ²]	[m]
0.14:	1	2.5:	20
0.25:	2	4.0:	32
0.50:	4	6.0:	48
0.75:	6	10.0:	80
1.00:	8	16.0:	127
1.50:	12	25.0:	199

If results vary for the two different current flow directions, cable length is not displayed. In this case, capacitive or inductive components are apparently present which would distort the calculation.

This table only applies to cables made with commercially available copper conductors and cannot be used for other materials (e. g. aluminum)!

Note

Minimum Cross-Section

The cross-section of the device under test must be observed when the RLO(25A) measurement is used. As opposed to machines in accordance with DIN EN 60204, system components are frequently laid out with a significantly smaller cross-section. Due to the high amperage of the test current, small cross-sections may result in undesired warm-up or damage under certain circumstances.

10.2.6 Evaluation of Measured Values

See tables in section 27.1.

11 RISO – Measurement of Insulation Resistance

11.1 Insulation Measurement with Constant Test Voltage

Select the measuring function:



11.1.1 General

In order to avoid hazards or damage resulting from fault current and creepage current which can occur due to faulty cable insulation, IEC 60364-6/DIN VDE 0100-600 requires testing of insulation resistance between the active conductors and the protective conductor connected to earth.

Measurement Principle

Insulation resistance measurement is performed by applying a constant direct voltage of 50 V to 1 kV. In accordance with DIN EN 61557-2, test current is at least 1 mA, and short-circuit current is limited to < 1.6 mA for safety reasons.

11.1.2 Help Function

Illustrations and measurement instructions can be displayed by pressing the **HELP** key.

The help function is exited by pressing the **ESC** key.

11.1.3 Parameters

Test Duration – Measuring Times

ton:
AUTO

1/1

ton: **AUTO**

ton: 1 1min

ton: 5 5min

↑

↓

→

✓

AUTO: measurement is ended after the measured value has been acquired.

Continuous measurement is possible by pressing and holding **ON/START**.

1 min: test duration of 1 minute

5 min: test duration of 5 minutes

Test Voltages

500V

Uiso

1/1

U_N: **500V**

U_N: 50V

U_N: 100V

U_N: 250V

U_N: 325V

U_N: 500V

U_N: 1000V

↑

↓

←

+

Various preset parameters are available for setting test voltage. The list can be extended with the help of the **+** editing function. This function is made available as soon as the cursor is located in the parameter selection column (see also section 8.5). This list makes it possible to select a test voltage which deviates from nominal voltage (and is usually lower) for measurements at sensitive components, as well as systems with voltage limiting devices.

Limits – Limit Values for Insulation Resistance

Limits

Limit value: **R: >1,00MΩ**

1/1

↑

↓

→

✓

RISO < Limit value

UL / RL

R: >50kΩ

R: >100kΩ

R: >500kΩ

R: >1,00MΩ

R: >2,00MΩ

R: >5,00MΩ

R: >7,00MΩ

R: >10,0MΩ

R: >70,0MΩ

R: >100MΩ

Setting a limit value for insulation resistance makes it possible to indicate that a minimum value has been fallen short of. If the measured value for **Riso** is below this limit, the **UL/RL LED** lights up red. Various fixed parameters or an editable value can be selected. The limit value is displayed above the measured value.

Conductor Relationship – Polarity

01/11

AUTO

1/2

L1-PE

L2-PE

L3-PE

H-PE

L+N-PE

L1-H

L2-H

L3-H

L1-L2

L2-L3

↑

↓

↶

2-Pole Measurement
(selection relevant for report generation only):

The specification of conductor relationship points makes it possible to allocate measured values and measuring points to each other. Corresponding report generation is possible after measurement has been completed by pressing the save button (softkey). Selection can be made between manual setting and the **AUTO** function. With the help of the **AUTO** function, the user can switch through the various conductor relationships, one after the other, by pressing the **IA_N** key (see also section 8.6).

11.1.4 Riso Measurement

Connection

Probe 1(L)
Probe 3(PE)

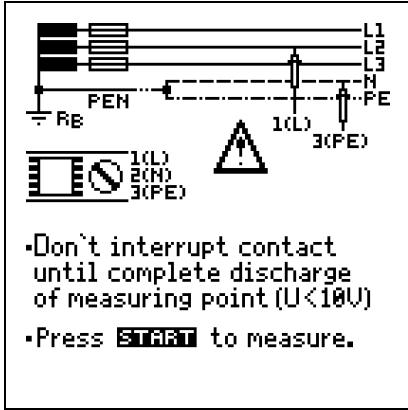

Note

N and PE must be interrupted for systems without RCD.

Note

Checking Measurement Cables Before Measurements
Before performing insulation measurement, the test probes on the measurement cables should be short-circuited in order to assure that the instrument displays a value of less than 1 kΩ. In this way, incorrect connection can be avoided and broken measurement cables can be detected.



Attention!

Insulation resistance may only be measured at voltage-free devices.



Attention!

Do not touch the test probes during the measurement – danger of injury!



Attention!

Capacitive devices under test are charged during this measurement. Incorrect discharging results in a life-threatening situation. For this reason, the connection between the test instrument and the device under test may not be interrupted until voltage at the test probes has dropped to below 10 V.

Measuring Procedure

- Connect probes.
- Set parameters.
- Start: Press the ON/START key.
- Constant test voltage is applied.
- Measured values are display when the measured value for Riso is stable or test time has elapsed.
- Measurement is ended as soon as U is less than 10 V.

Continuous measurement:
Press and hold ON/START with $t_{on} = \text{AUTO}$ setting.



Quick polarity reversal if parameter is set to AUTO:
01/11 ... 11/11: L1-PE ... L1-L3

The measurement can be aborted by pressing ON/START or ESC.

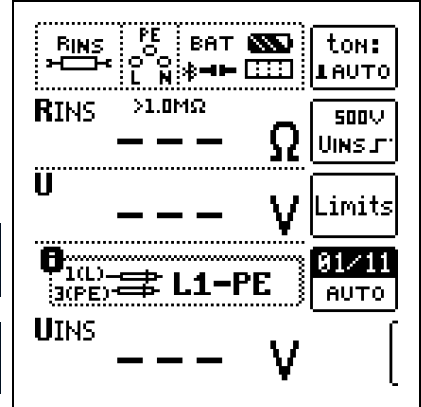

The following measured values are displayed:

- **Riso:** insulation resistance
- **U:** momentary voltage at the test probes
- **Uiso:** voltage at the moment insulation resistance was acquired

The following points must be observed:

- High cable capacitance extends measuring time.
- The duration of the measurement can be increased by pressing and holding the ON/START key – due to the fact that the battery is subjected to a heavy load during this measurement, it should be kept as short as possible.

11.2 Riso Ramp – Insulation Measurement with Rising Test Voltage

Select the measuring function:



11.2.1 General

Insulation and semiconductor junction quality can be determined with the RISO Ramp measuring function. This function is used in the following cases:

- Detection of weak points in the insulation
- Function testing of voltage-sensitive components
- Determination of sparkover voltage for spark gaps

Measurement Principle

Insulation testing is conducted by applying a rising test voltage ramp which is increased continuously up to selected maximum test voltage U . If a voltage drop occurs or if maximum leakage current is exceeded, measurement is aborted and sparkover or breakdown voltage U_{iso} is displayed.

11.2.2 Help Function

Illustrations and measurement instructions can be displayed by pressing the **HELP** key.

The help function is exited by pressing the **ESC** key.

11.2.3 Parameters

Breakdown Voltage Limit Values

Limit value **I_{LIM}** can be set for the purpose of current monitoring. Measurement is aborted if the limit value is exceeded. Various fixed parameters or an editable value can be selected.

Test Voltage

Various preset parameters are available for setting test voltage. The list can be extended with the help of the  editing function. This function is made available as soon as the cursor is located in the parameter selection column (see also section 8.5).

Limit – Limit Values for Breakdown Voltage

A target range can be defined by setting upper and lower limit values for insulation voltage U_{ISO} . If the measured value is not within this range, the **UL/RL LED** lights up red. An editable value is available for the adjustment of each limit value.

Conductor Relationship – Polarity

The specification of conductor relationship points makes it possible to allocate measured values and measuring points to each other. Corresponding report generation is possible after measurement has been completed by pressing the save button (softkey). Selection can be made between manual setting and the **AUTO** function. With the help of the **AUTO** function, the user can switch through the various conductor relationships, one after the other, by pressing the $I_{\Delta N}$ key (see also section 8.6).

11.2.4 RISO Ramp Measurement

Connection

Probe 1(L)
Probe 3(PE)

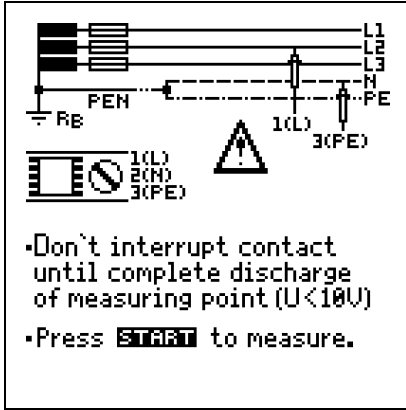

Press briefly:

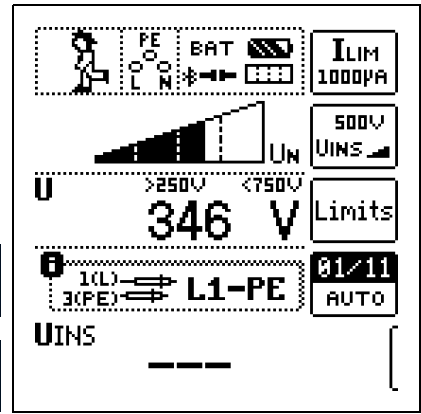

Quick polarity reversal if parameter is set to AUTO:
01/11 ... 11/11: L1-PE ... L1-L3

After pressing the **ON/START** key test voltage is continuously increased until specified nominal voltage U_N is reached. **U** is the voltage which is measured at the test probes **during and after testing**. This voltage drops to a value of less than 10 V (see section entitled "Discharging the Device Under Test").

The measurement can be aborted by pressing **ON/START** or **ESC**.

Test voltage is continuously increased until one of the following events occurs:

- Breakdown in the form of arc-over or a voltage drop
- Nominal voltage (selected test voltage U_N) is reached
- Current flows at the selected amperage
- Measurement is aborted by pressing **ON/START** or **ESC**

The following measured values are displayed:

- **U**: momentary test probe voltage
- **Uiso**: either breakdown or nominal voltage depending on the course of test events



Attention!

Insulation resistance may only be measured at voltage-free devices.



Attention!

Do not touch the test probes during the measurement – mortal danger!



Attention!

Capacitive devices under test are charged during this measurement. Incorrect discharging results in a life-threatening situation. For this reason, the connection between the test instrument and the device under test may not be interrupted until voltage at the test probes has dropped to below 10 V.

Measuring Procedure

- Connect probes.
- Set parameters.
- Start: Press the **ON/START** key.
- Rising test voltage is applied.
- Measured values are displayed when:
 - Breakdown occurs in the form of arc-over or a voltage drop or
 - Nominal test voltage is reached or
 - Current flows at the selected amperage
- Measurement is ended as soon as **U** is less than 10 V.

11.2.5 Notes on Measurement with the Ramp Function

Insulation measurement with ramp function serves the following purposes:

- Detect weak points in the test object's insulation
- Determine tripping voltage of voltage limiting components and test them for correct functioning. These components may include, for example, varistors, overvoltage limiters (e.g. DEHNguard® from Dehn+Söhne) and spark gaps.

The test instrument uses continuously rising test voltage for this measuring function, up to the selected maximum voltage limit. The measuring procedure is started by pressing the **ON/START** key and runs automatically until one of the following events occurs:

- The selected voltage limit is reached
 - The selected current limit is reached
- or
- Sparkover occurs (spark gaps)

Differentiation is made amongst the following three procedures for insulation measurement with ramp function:

Testing overvoltage limiters or varistors or determining their tripping voltage:

- Select maximum voltage such that the anticipated breakdown voltage of the device under test is roughly one third of this value (observe manufacturer's data sheet if applicable).
- Select the current limit value in accordance with actual requirements or the manufacturer's data sheet (characteristic curve of the device under test).

Determining tripping voltage for spark gaps:

- Select maximum voltage such that the anticipated breakdown voltage of the device under test is roughly one third of this value (observe manufacturer's data sheet if applicable).
- Select the current limit value in accordance with actual requirements within a range of 5 to 10 μA (response characteristics are too unstable with larger current limit values, which may result in faulty measurement results).

Detecting weak points in the insulation:

- Select maximum voltage such that it does not exceed the test object's permissible insulation voltage; it can be assumed that an insulation fault will occur even with a significantly lower voltage if an accordingly lower maximum voltage value is selected (nevertheless at least greater than anticipated breakdown voltage) – the ramp is less steep as a result (increased measuring accuracy).
- Select the current limit value in accordance with actual requirements within a range of 5 to 10 μA (see also settings for spark gaps).

11.3 Evaluation of Measured Values

Instrument measuring error must be taken into consideration in order to assure that the limit values set forth in DIN VDE regulations are not fallen short of. The required minimum display values for insulation resistance can be determined with the help of the tables in section 27.1. These values take maximum device error into consideration (under nominal conditions of use). Intermediate values can be interpolated.

12 RCD – Testing of Residual Current Devices



12.1 General

Residual current devices (RCDs) are used for protection by means of automatic shutdown of supply power in the event of indirect contact. The effectiveness of this measure must be examined by means of visual inspection and measurement. It must be verified that shutdown takes place no later than upon reaching rated differential current $I_{\Delta N}$, and the agreed upon limit value for permissible touch voltage must not be exceeded.

The **PROFITEST PRIME** offers the opportunity of testing RCDs which are sensitive to alternating, pulsed and direct current with non-delayed (general type), short-time delayed (type G) or time delayed tripping (type **S**).

The following table provides an overview of the response characteristics of various types of RCDs.

Types of Residual Current

	AC	A	F	B/B+	A – EV	B/B+ MI
Sinusoidal 	X	X	X	X	X	X
Half-wave 	—	X	X	X	X	X
DC 	—	—	—	X	—	X
+ 6 mA DC	—	—	—	—	X	X

Selection is possible from the following measuring functions:

- $U_{I\Delta N}$: touch voltage measurement
- RCD I_F : measurement of tripping current with rising test current
- RCD $I_{\Delta N}$: measurement of time to trip with constant test current
- RCD $I_F + I_{\Delta N}$: simultaneous measurement of time to trip and tripping current with rising test current

Refer to section 25, “Characteristic Values”, as of page 102 when selecting the measuring function.

Information regarding status information can be found in section 24.

Note

Generation of DC Residual Current

All three probes are required in this case: (1)L, (2)N and (3)PE. Two probes, namely 1(L) and 3(PE), suffice when generating AC current or half-wave current.

12.2 Measurement of Touch Voltage and Time to Trip with Nominal Residual Current

Select the measuring function:



12.2.1 General

Each of the 3 tripping tests described on the following pages begins with a touch voltage measurement for safety reasons before the actual tripping test is started. Respective maximum touch voltage U_L must be specified here under limits, and must not be exceeded. If prevailing touch voltage $U_{I\Delta N}$ is greater than limit value U_L , safety shutdown ensues.

Measuring Method

The instrument uses a measuring current of only $\frac{1}{3}$ nominal residual current for the determination of touch voltage $U_{I\Delta N}$ which occurs at nominal residual current. This prevents tripping of the RCCB.

This measuring method is especially advantageous, because touch voltage can be measured quickly and easily at any electrical outlet without tripping the RCCB.

The usual, complex measuring method involving testing for the proper functioning of the RCD at a given point, and subsequent substantiation that all other systems components requiring protection are reliably connected at low resistance values to the selected measuring point via the PE conductor, is made unnecessary.



Attention!

In order to prevent the loss of data in data processing systems, perform a data backup before starting the measurement and switch off all consumers.

12.2.2 Help Function

Illustrations and measurement instructions can be displayed by pressing the **HELP** key.

The help function is exited by pressing the **ESC** key.

12.2.3 Parameters

The **nominal residual current** $I_{\Delta N}$ parameter, which is relevant for touch voltage, can be set in the following submenu:

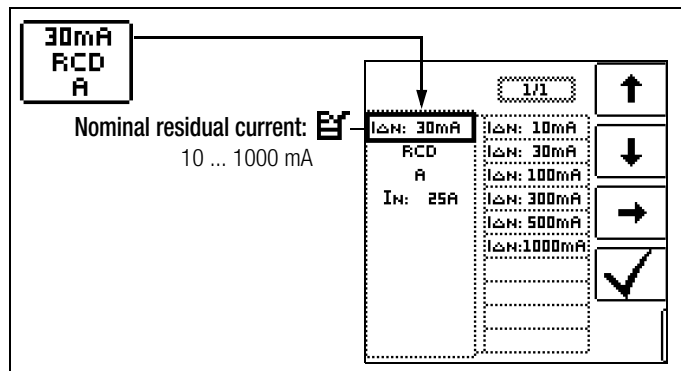

Limit Values

The test instrument offers the option of a display in the event that maximum permissible touch voltage U_L is exceeded.

U_L can be configured to this end.

If prevailing touch voltage $U_{\Delta N}$ is greater than limit value U_L , safety shutdown ensues. The **UL/RL LED** lights up red.

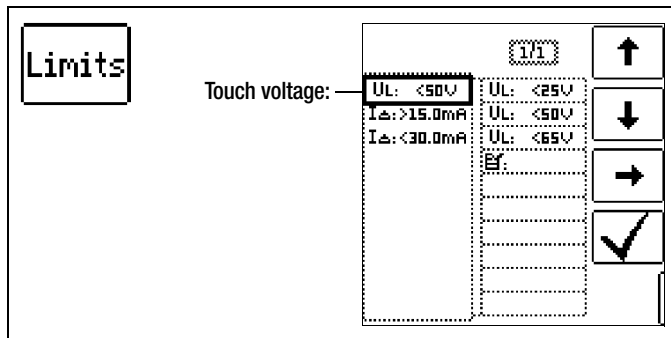

12.2.4 RCD $I_{\Delta N}$ – Measurement of Time to Trip with Nominal Current

Measuring Connections

Measurement with full and half-wave:

- Probe 1(L)
- Probe 3(PE)

Measurement with direct current:

- Probe 1(L)
- Probe 2(N)
- Probe 3(PE)

Refer to the notes in section 12.7 when performing the measurement.

Measuring Procedure

- Set the parameters.
- Start **touch voltage measurement**: Press the **ON/START** key.
 - Display of measured values: $U_{\Delta N}$, RE, U, f
- Start **touch voltage measurement and tripping test**: Press the $I_{\Delta N}$ key.
 - Test current is applied.
 - Measurement is ended when the RCD is tripped or the final value is reached.
 - Display of measured values: $U_{\Delta N}$, t_a , RE, U, f

Start the measurement.

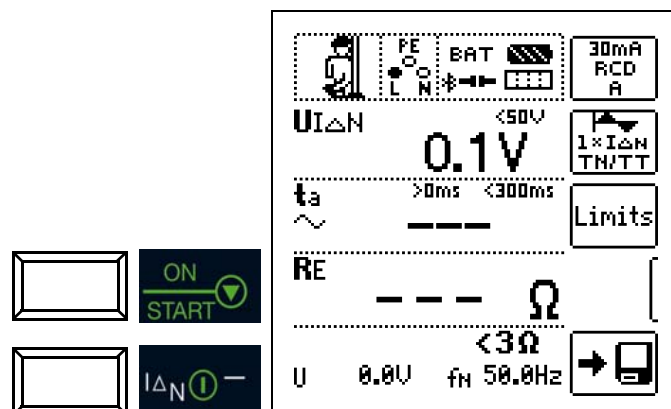

Measurement can be aborted by pressing **ON/START**, $I_{\Delta N}$ or **ESC**.

The following measured values are displayed:

- $U_{\Delta N}$: touch voltage relative to nominal residual current
- t_a : time to trip
- RE: earth loop resistance
- U: voltage at the test probes before starting the tripping test – U_N is displayed if voltage value U_{max} deviates from nominal voltage by 10%.
- f: frequency of the voltage at the test probes before starting the tripping test – f_N is displayed if frequency f_{max} deviates from nominal frequency by 1%.

Tripping Test with Nominal Residual Current

The tripping test need only be performed at one measuring point for each RCCB.

If touch voltage $U_{\Delta N}$ reaches a value of greater than U_L during the measurement, safety shutdown ensues.

Unintentional Tripping of the RCD due to Bias Current within the System

Any bias current which might occur can be ascertained as described in section 18 on page 70 with the help of a current clamp transformer. The RCCB may be tripped during the testing of touch voltage if extremely large bias currents are present within the system, or if a test current was selected which is too great for the RCCB.

After touch voltage has been measured, testing can be performed to determine whether or not the RCCB is tripped within the selected time limit values at nominal residual current.

Unintentional Tripping of the RCD due to Leakage Current in the Measuring Circuit

Measurement of touch voltage with 30% nominal residual current does not normally trip an RCCB. However, the tripping limit may be exceeded as a result of leakage current in the measuring circuit, e.g. due to interconnected consumers with EMC circuit such as frequency converters and PCs.

Limit Values for Allowable, Continuous Touch Voltage

The limit for allowable, continuous touch voltage is equal to $U_L = 50$ V for alternating voltages (international agreement). Lower values have been established for special applications (e.g. medical applications: $U_L = 25$ V).



Attention!

If touch voltage is too high, or if the RCCB is not tripped, the system must be repaired (e.g. earthing resistance is too high, defective RCCB etc.)!

3-Phase Connections

For proper RCD testing at three-phase connections, the tripping test must be conducted for one of the three phase conductors (L1, L2 or L3).

Inductive Power Consumers

Voltage peaks may occur within the measuring circuit if inductive consumers are shut down during an RCCB trip test. If this is the case, the test instrument might not display any measured value (---). If this message appears, switch all consumers off before performing the tripping test. In extreme cases, one of the fuses in the test instrument may blow, and/or the test instrument may be damaged.

12.3 RCD I_F – Testing Residual Current Devices by Measuring Tripping Current with Rising Test Current

Select the measuring function:



12.3.1 General

This test instrument offers the option of testing type B RCDs with smooth direct current.

DIN EN 61557-6 requires testing of these RCDs in both current flow directions.

Other RCDs can be selected under the test object parameter, and other waveforms can be selected under the Test parameter.

Measurement Principle

The tripping current of RCDs is measured by applying a rising test current.

12.3.2 Help Function

Illustrations and measurement instructions can be displayed by pressing the **HELP** key.

The help function is exited by pressing the **ESC** key.

12.3.3 Parameters

The measurement parameters can be set in the submenus which are described below:

Test Object Parameter

The following characteristic values can be configured for the device under test:

- $I_{\Delta N}$: nominal residual current
- Type of device, e.g. RCD, RCD-S
- Characteristic, e.g. type AC, type B
- I_N : nominal current

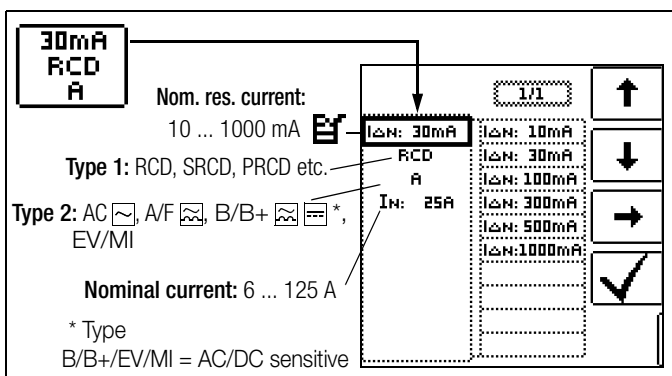

Test Parameters

The type of test current can be selected. The function's starting and final values are dictated by this setting (see also section 25, "Characteristic Values", as of page 102).

Selection is possible from the following options:

- Full-wave, 0°
- Positive half-wave
- Negative half-wave
- Positive direct current
- Negative direct current

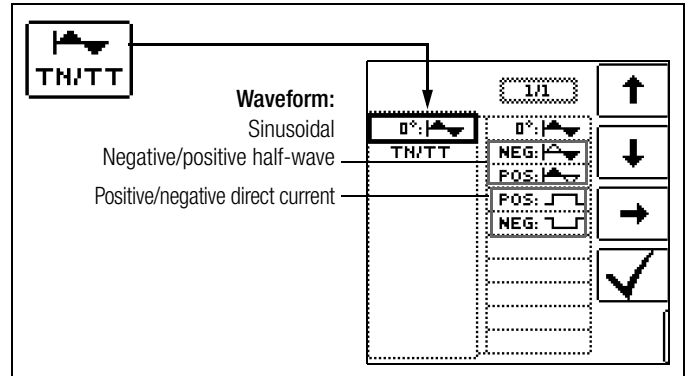

The type of electrical system can be selected for report generation:

- TN/TT
- IT

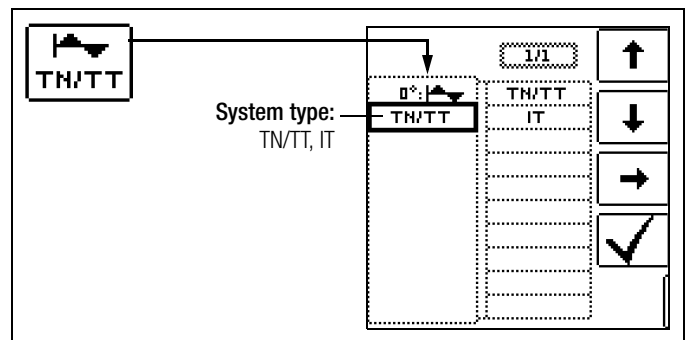

Limit Values

The test instrument offers the option of displaying limit value violations.

The following limit values can be configured:

- U_L : maximum permissible touch voltage
- $I_{\Delta >}$: minimum tripping current
- $I_{\Delta <}$: maximum tripping current

If touch voltage $U_{i\Delta N}$ is greater than limit value U_L , safety shutdown ensues. The **UL/RL LED** lights up red.

If the measured value for tripping current I_{Δ} is not within the specified limits, the **RCD FI LED** lights up red.

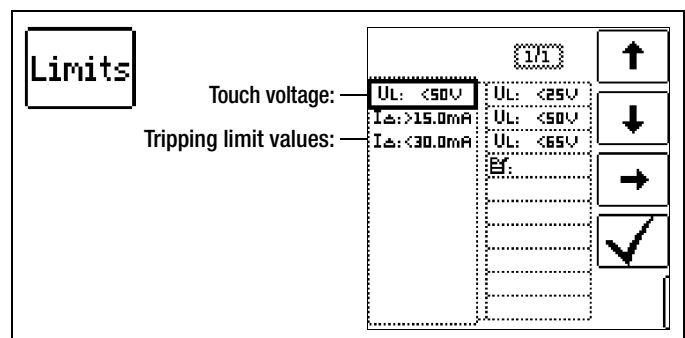

12.3.4 RCD If Δ Measurement

Connection

Measurement with full and half-wave:

Probe 1(L)

Probe 3(PE)

Measurement with direct current:

Probe 1(L)

Probe 2(N)

Probe 3(PE)

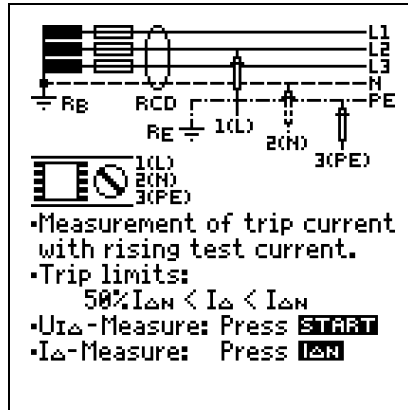

Note

Half-wave test: Testing is conducted with rising test current with up to $1.4 \times I_{\Delta N}$.
Setting the tripping current factor has no effect.

Refer to the notes in section 12.7 when performing the measurement.

Measuring Procedure

- ◇ Set the parameters.
- ◇ Start touch voltage measurement:
Press the ON/START key.
- Display of measured values: $U_{I\Delta N}$, RE, U, f
- ◇ Start touch voltage measurement and tripping test: Press the $I_{\Delta N}$ key.
- Test current is applied.
- Measurement is ended when the RCD is tripped or the final value is reached.
- Display of measured values: $U_{I\Delta N}$, I_{Δ} , RE, U, f

The following measured values are displayed:

- $U_{I\Delta N}$: touch voltage relative to nominal residual current
- I_{Δ} : residual tripping current
- RE: earth loop resistance
- U: voltage at the test probes before starting the tripping test,
Un is displayed if voltage U_{max} deviates from nominal voltage by 10%
- f: frequency of the applied voltage,
fn is displayed if frequency f_{max} deviates from nominal frequency by 1%

Start the measurement.

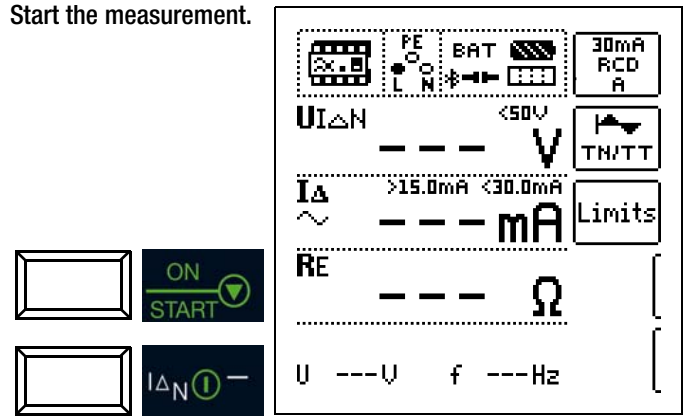

Measurement can be aborted by pressing ON/START, $I_{\Delta N}$ or ESC.

12.4 RCD I_{ΔN} – Testing RCDs by Measuring Time to Trip with Constant Test Current

Select the measuring function:

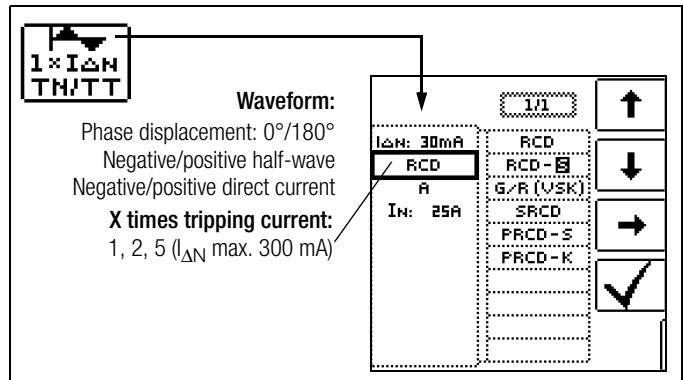

12.4.1 General

This measuring function makes it possible to test RCDs with sinusoidal test current in accordance with DIN EN 61557-6.

Other waveforms can be selected under the Test parameter.

Measurement Principle

Very high constant test current is applied and time to trip, or holding time in the event that tripping does not occur, is measured.

12.4.2 Help Function

Illustrations and measurement instructions can be displayed by pressing the **HELP** key.

The help function is exited by pressing the **ESC** key.

12.4.3 Parameters

The measurement parameters can be set in the submenus which are described below:

Test Object Parameter

The following characteristic values can be configured for the device under test:

- I_{ΔN}: nominal residual current
- Type of device, e.g. RCD, RCD-S
- Characteristic, e.g. type AC, type B
- I_N: nominal current

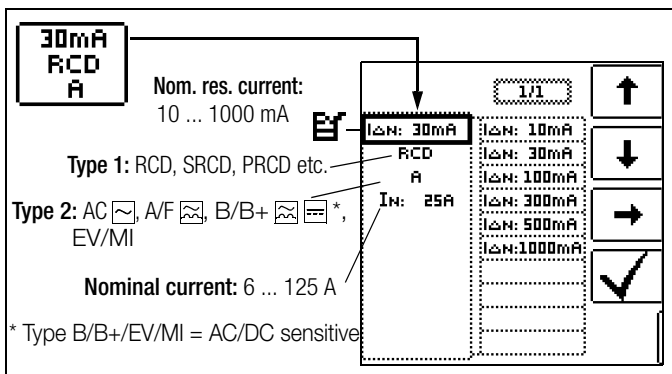

One of the following waveforms can be selected for the test current to be applied:

- Full-wave, 0°
- Full-wave, 180°
- Positive half-wave
- Negative half-wave
- Positive direct current
- Negative direct current

Selection options for the tripping current factor:

- 0.5 x I_{ΔN} + 1 x I_{ΔN}: no-trip test with half nominal residual current (duration: 1 s) with subsequent tripping test with nominal residual current
- 1 x I_{ΔN}: tripping test with nominal residual current
- 2 x I_{ΔN}: tripping test with 2 times nominal residual current
- 5 x I_{ΔN}: tripping test with 5 times nominal residual current

The type of electrical system can be selected for report generation:

- TN/TT
- IT

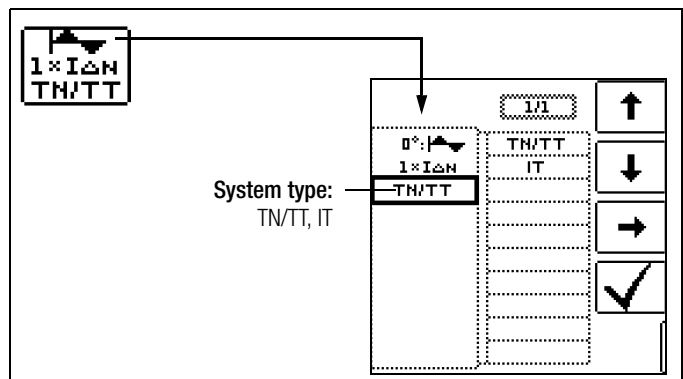

Limit Values

The test instrument offers the option of displaying limit value violations.

The following limit values can be configured:

- U_L: maximum permissible touch voltage
- t_{a>}: minimum time to trip
- t_{a<}: maximum time to trip

If touch voltage U_{IΔN} is greater than limit value U_L, safety shutdown ensues. The **UL/RL LED** lights up red.

If the measured value for time to trip t_a is not within the specified limits, the **RCD FI LED** lights up red.

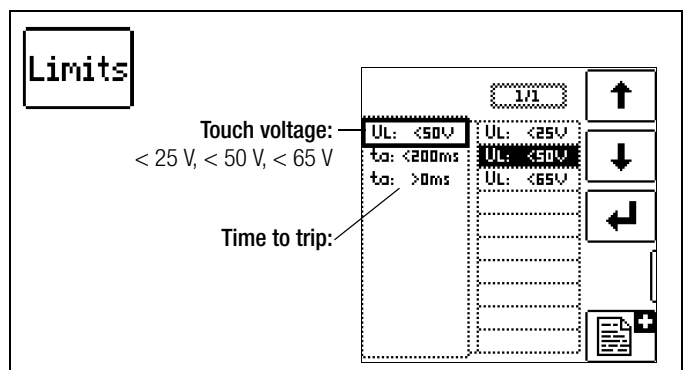

12.4.4 RCD I Δ N Measurement

Connection

Measurement with full and half-wave:

Probe 1(L)

Probe 3(PE)

Measurement with direct current:

Probe 1(L)

Probe 2(N)

Probe 3(PE)

Refer to the notes in section 12.7 when performing the measurement.

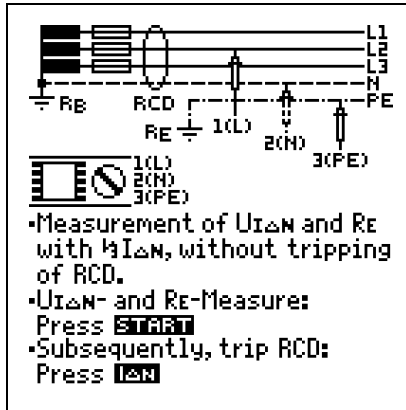

Measuring Procedure

- ◇ Set the parameters.
- ◇ Start touch voltage measurement: Press the **ON/START** key.
- Display of measured values: $U_{I\Delta N}$, R_E , U, f
- ◇ Start touch voltage measurement and tripping test: Press the **I Δ N** key.
- Test current is applied.
- Measurement is ended when the RCD is tripped or the final value is reached.
- Display of measured values: $U_{I\Delta N}$, t_a , R_E , U, f

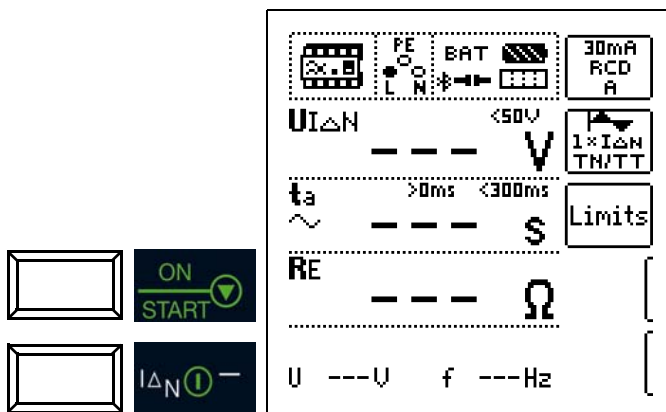

Measurement can be aborted by pressing **ON/START**, **I Δ N** or **ESC**.

The following measured values are displayed:

- $U_{I\Delta N}$: touch voltage relative to nominal residual current
- t_a : tripping time
- R_E : earth loop resistance
- U: voltage at the test probes before starting the tripping test, U_N is displayed if voltage U_{max} deviates from nominal voltage by 10%
- f: frequency of the applied voltage, f_N is displayed if frequency f_{max} deviates from nominal frequency by 1%

12.5 RCD $I_{F\Delta} + I_{\Delta N}$ – Testing RCDs by Simultaneously Measuring Tripping Current and Time to Trip with Rising Test Current

Select the measuring function:



RCD $I_{F\Delta} + I_{\Delta N}$

12.5.1 General

The advantage of this measuring function in contrast to individual measurement of $I_{\Delta N}$ and t_a is the simultaneous measurement of breaking time and breaking current by means of a test current which is increased in steps, during which the RCD is tripped only once.

The intelligent ramp is subdivided into time segments of 300 ms each between the initial current value (35% $I_{\Delta N}$) and the final current value (130% $I_{\Delta N}$). This results in a gradation for which each step corresponds to a constant test current which is applied for no longer than 300 ms, assuming that tripping does not occur.

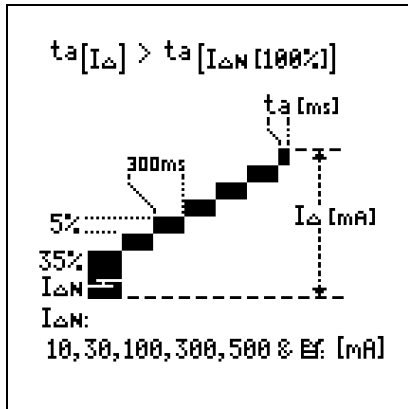

And thus both tripping current and tripping time are measured and displayed.

Measurement Principle

Test current which is increased in steps within a range of 0.35 to $1.3 \times I_{\Delta N}$ is applied. Time to trip and tripping current are measured simultaneously.

12.5.2 Help Function

Illustrations and measurement instructions can be displayed by pressing the **HELP** key.

The help function is exited by pressing the **ESC** key.

12.5.3 Parameters

The measurement parameters can be set in the submenu which are described below:

Test Object Parameter

The following characteristic values can be configured for the device under test:

- $I_{\Delta N}$: nominal residual current
- Type of device, e.g. RCD, RCD-S
- Characteristic, e.g. type AC, type B
- I_N : nominal current
- System type: TN/TT, IT – specified for report generation

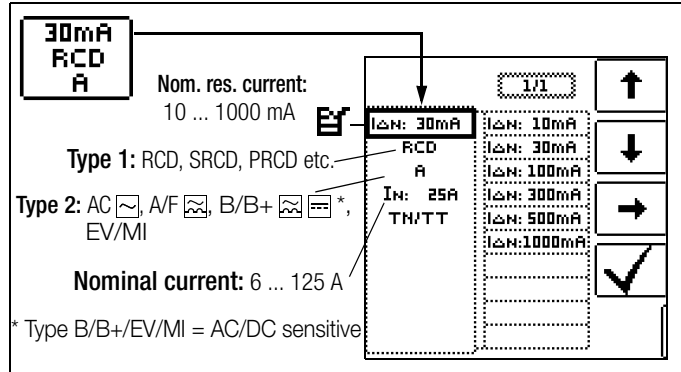

Limit Values

The test instrument offers the option of displaying limit value violations.

The following limit values can be configured:

- **UL**: maximum permissible touch voltage
- $t_a >$: minimum time to trip
- $t_a <$: maximum time to trip
- $I_{\Delta} >$: minimum tripping current
- $I_{\Delta} <$: maximum tripping current

If prevailing touch voltage $U_{\Delta N}$ is greater than limit value **UL**, safety shutdown ensues. The **UL/RL LED** lights up red.

If tripping time t_a and/or tripping current I_{Δ} is not within the specified limits, the **RCD FI LED** lights up red.

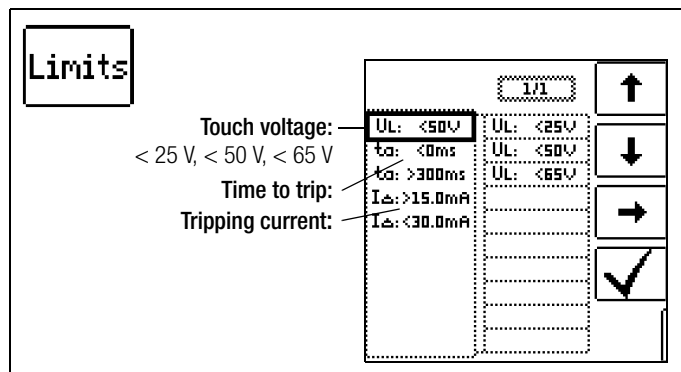

12.5.4 RCD IF Δ + $I_{\Delta N}$ Measurement

Connection

Probe 1(L)
Probe 3(PE)

Refer to the notes in section 12.7 when performing the measurement.

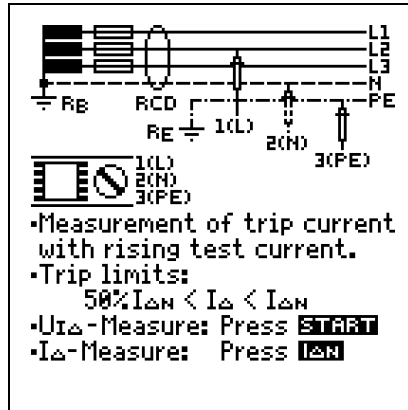

Measuring Procedure

- ⇒ Set the parameters.
- ⇒ Start touch voltage measurement:
Press the **ON/START** key.
- Display of measured values: $U_{I\Delta N}$, RE, U, f
- ⇒ Start touch voltage measurement and tripping test: Press the **I Δ N** key.
- Test current is applied.
- Measurement is ended when the RCD is tripped or the final value is reached.
- Display of measured values: $U_{I\Delta N}$, ta, I_{Δ} , RE, U, f

The following measured values are displayed:

- $U_{I\Delta N}$: touch voltage relative to nominal residual current
- ta: tripping time
- I_{Δ} : tripping current
- RE: earth loop resistance
- U: voltage at the test probes before starting the tripping test, **UN** is displayed if voltage U_{max} deviates from nominal voltage by 10%
- f: frequency of the applied voltage, **fn** is displayed if frequency f_{max} deviates from nominal frequency by 1%

Start the measurement.

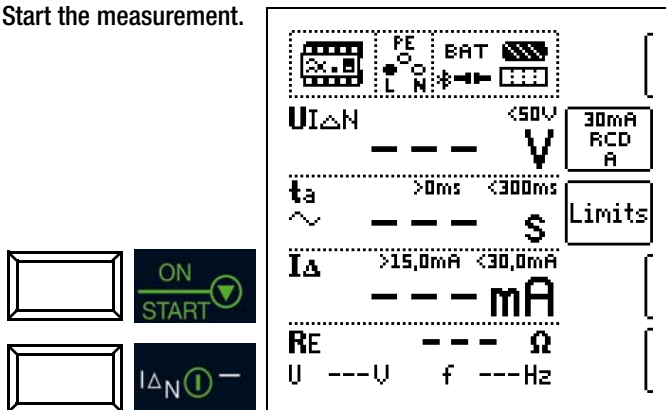

Measurement can be aborted by pressing **ON/START**, **I Δ N** or **ESC**.

12.6 Special Tests for Systems and RCDs

12.6.1 Testing Systems and RCCBs with Rising Residual Current (AC) for Type B/B+ and EV/MI RCDs

Select the measuring function:



General

In accordance with VDE 0413-6, it must be substantiated that, with smooth direct current, residual operating current is no more than twice the value of rated residual current $I_{\Delta N}$. A continuously rising direct current, beginning with 0.2 times rated residual current $I_{\Delta N}$, must be applied to this end. If current rise is linear, rising current may not exceed twice the value of $I_{\Delta N}$ within a period of 5 seconds.

Testing with smooth direct current must be possible in both test current directions.

12.6.2 Testing RCCBS with $5 \cdot I_{\Delta N}$

Measurement of time to trip is performed in this case with 5 times nominal residual current.

Note

Measurements performed with 5 times nominal residual current are required for testing type **S** and **G** RCCBs in the manufacturing process. They're used for personal safety as well.

Measurement can be started with the positive **half-wave "0°"** or with the **negative half-wave "180°"** (full-wave setting).

Both measurements must nevertheless be performed. The longer of the two tripping times is decisive regarding the condition of the tested RCCB. Both values must be less than 40 ms.

Set parameters.

– Start with the positive or negative half-wave of the respective full-wave

Waveform

0°: Start with positive half-wave
 180°: Start with negative half-wave
 Negative half-wave
 Positive half-wave
 Positive direct current
 Negative direct current

Set the Parameter – 5 Times Nominal Residual Current

X times tripping current:
 5 times tripping current

Start the measurement

ON START
 $I_{\Delta N}$

12.6.3 Testing of RCCBs which are Suited for Pulsating DC Residual Current

Select the measuring function:



General

In this case, RCCBs can be tested with either positive or negative half-waves. The standard calls for tripping at 1.4 times nominal current.

Set the Parameter – Positive or Negative Half-Wave

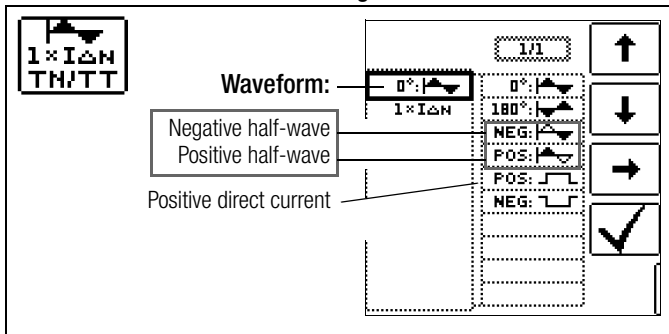

Set the Parameter – Test With and Without “No-Trip Test”

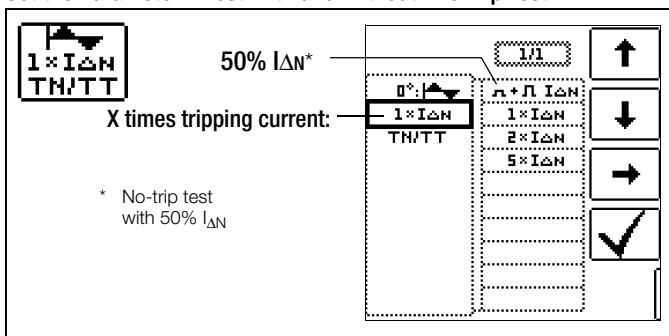

No-Trip Test

If, during the no-trip test which lasts for 1 second, the RCCB trips too early at 50% $I_{\Delta N}$, i.e. before the actual tripping test starts, the pop-up window shown at the right appears.

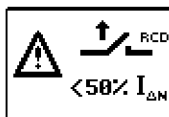

Note

According to DIN EN 50178 (VDE 160), only type B RCCBs (AC-DC sensitive) can be used for equipment with > 4 kVA, which is capable of generating smooth DC residual current (e.g. frequency converters). Tests with pulsating DC residual current only are not suitable for these RCCBs. Testing must also be conducted with smooth DC residual current in this case.



Note

Measurement is performed with positive and negative half-waves when testing RCCBs during manufacturing. If a circuit is charged with pulsating direct current, the function of the RCCB can be executed with this test in order to assure that the RCCB is not saturated by the pulsating direct current so that it no longer trips.

12.6.4 Systems with Type RCD-S Selective RCCBs

Select the measuring function:



General

Selective RCCBs are used in systems which include two series connected RCCBs which are not tripped simultaneously in the event of a fault. These selective RCCBs demonstrate delayed response characteristics and are identified with the \square symbol.

Measuring Method

The same measuring method is used as for standard RCCBs (see sections 12.3 on page 44 and 12.4 on page 46).

If selective RCDs are used, earthing resistance may not exceed half of the value for standard RCCBs.

For this reason, the instrument displays twice the measured value for touch voltage.

Set Parameter – Selective

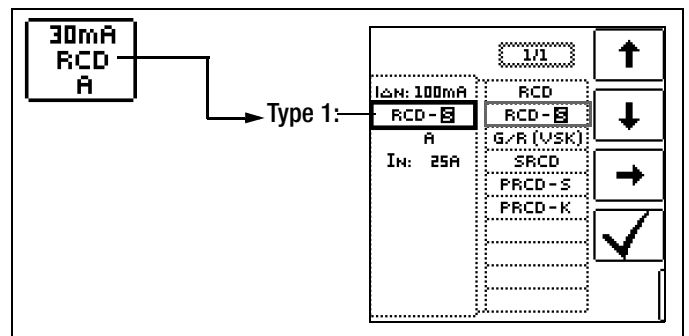

Start the measurement.

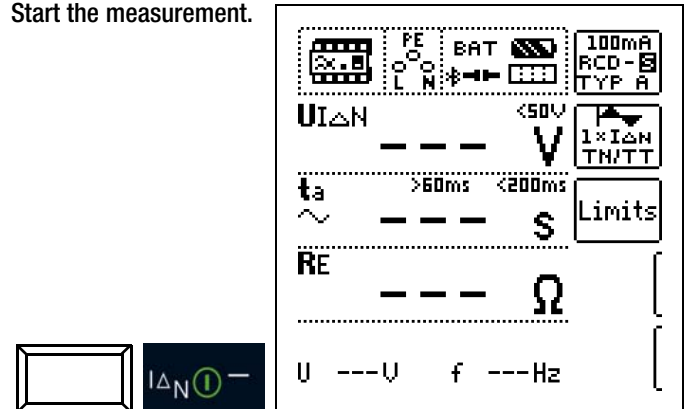

Tripping Test

- Press the $I_{\Delta N}$ key. The RCCB is tripped. Blinking bars appear at the display panel, after which time to trip t_a and earthing resistance R_E are displayed.

The tripping test need only be performed at one measuring point for each RCCB.

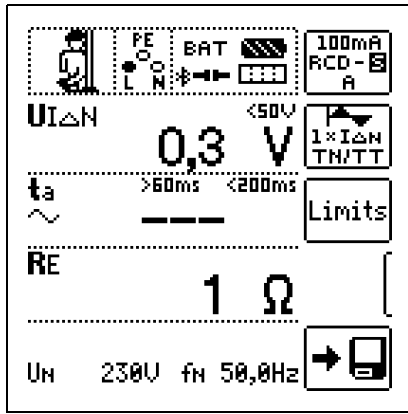

Measuring Method

The following can be measured, depending upon the measuring method:

- Time to trip t_A : tripping test with nominal residual current $I_{\Delta N}$ (the PRCD-K must be tripped at 50% nominal current)
- Tripping current I_{Δ} for testing with rising residual current $I_{F\Delta}$

Select the measuring function:



RCD $I_{F\Delta}$

or

RCD $I_{\Delta N}$

Note

Selective RCCBs demonstrate delayed response characteristics. Tripping performance is briefly influenced (up to 30 s) due to pre-loading during measurement of touch voltage. In order to eliminate pre-charging caused by the measurement of touch voltage, a waiting period must be observed prior to the tripping test. After the measuring sequence has been started (tripping test), blinking bars are displayed for approximately 30 seconds. Tripping times of up to 1000 ms are allowable. The tripping test is executed immediately after once again pressing the $I_{\Delta N}$ key.

Connection

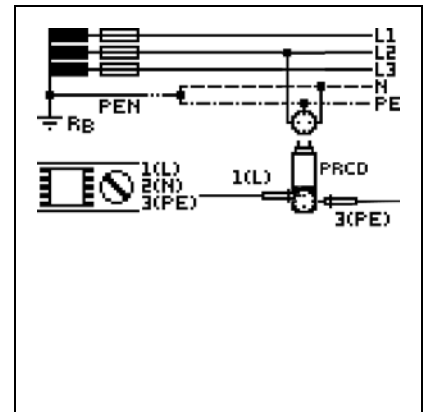

12.6.5 PRCDs with Non-Linear Type PRCD-K Elements

General

The PRCD-K is a portable RCD with electronic residual current evaluation laid out as an inline device which switches all poles (L, N and PE). Undervoltage tripping and protective conductor monitoring are additionally integrated into the PRCD-K.

The PRCD-K is equipped with undervoltage tripping, for which reason it has to be operated with line voltage, and measurements may only be performed in the on state (the PRCD-K switches all poles).

Terminology (from DIN VDE 0661)

Portable protective devices are circuit breakers which can be connected between power consuming devices and permanently installed electrical outlets by means of standardized plug-and-socket devices.

A reusable, portable protective device is a protective device which is designed such that it can be connected to movable cables.

Please be aware that a non-linear element is usually integrated into PRCDs, which leads to immediate exceeding of the greatest allowable touch voltage during $U_{I\Delta}$ measurements ($U_{I\Delta}$ greater than 50 V).

PRCDs which do not include a non-linear element in the protective conductor must be tested in accordance with section 12.6.6 on page 53.

Objective (from DIN VDE 0661)

Portable residual current devices (PRCDs) serve to protect persons and property. They allow for the attainment of increased levels of protection as provided by protective measures utilized in electrical systems for the prevention of electric shock as defined in DIN VDE 0100-410. They are to be designed such that they can be installed by means of a plug attached directly to the protective device, or by means of a plug with a short cable.

Set the Parameter – PRCD with Non-Linear Elements

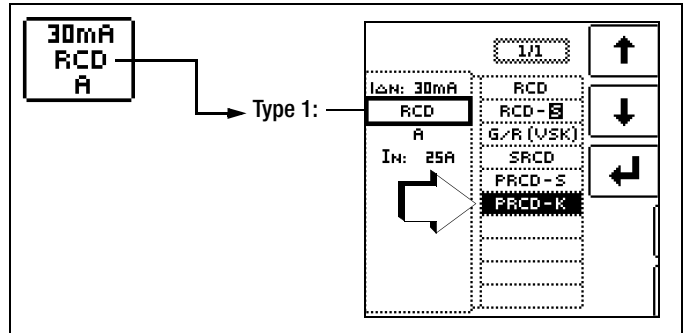

Start the measurement.

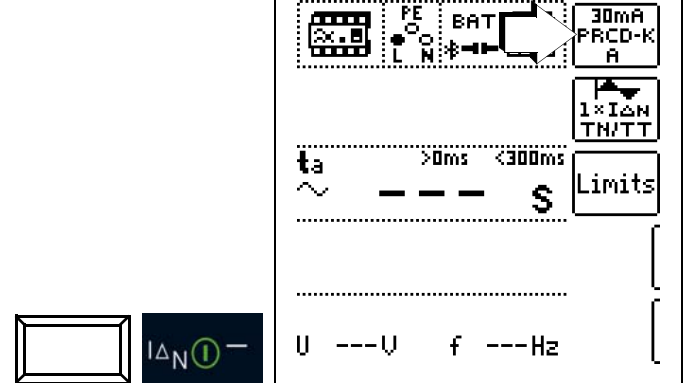

12.6.6 SRCD, PRCD-S (SCHUKOMAT, SIDOS or comparable)

Select the measuring function:

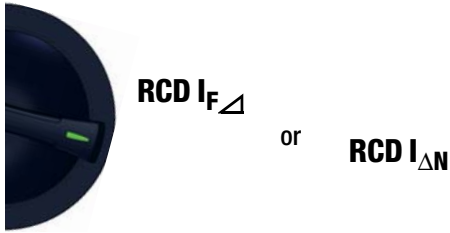

General

RCCBs from the SCHUKOMAT SIDOS series, as well as others which are of identical electrical design, must be tested after selecting the corresponding parameter.

Monitoring of the PE conductor is performed for RCDs of this type. The PE conductor is monitored by the summation current transformer. If residual current flows from L to PE, tripping current is cut in half, i.e. the RCCB must be tripped at 50% nominal residual current $I_{\Delta N}$.

Whether or not PRCDs and selective RCDs are of like design can be tested by measuring touch voltage $U_{I\Delta N}$. If a touch voltage $U_{I\Delta N}$ of greater than 70 V is measured at the PRCD of an otherwise error-free system, the PRCD more than likely contains a non-linear element.

PRCD-S

The PRCD-S (portable residual current device – safety) is a special, portable, protective device with protective conductor detection or protective conductor monitoring. The device serves to protect persons from electrical accidents in the low-voltage range (130 to 1000 V). The PRCD-S must be suitable for commercial use, and is installed like an extension cable between an electrical consumer – as a rule an electrical tool – and the electrical outlet.

Set Parameter – SRCD / PRCD

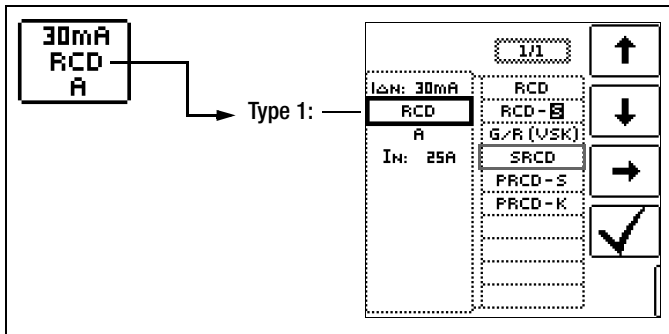

Start the measurement

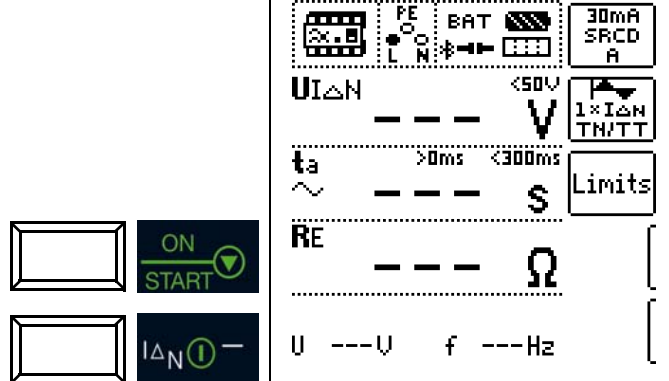

12.6.7 Type G or R RCCB

Select the measuring function:



General

In addition to standard RCCBs and selective RCDs, the special characteristics of the type G RCCB can also be tested with the test instrument.

The type G RCCB is an Austrian specialty and complies with the ÖVE/ÖNORM E 8601 device standard. Erroneous tripping is minimized thanks to its greater current carrying capacity and short-term delay.

Set the Parameter – Type G/R (VSK)

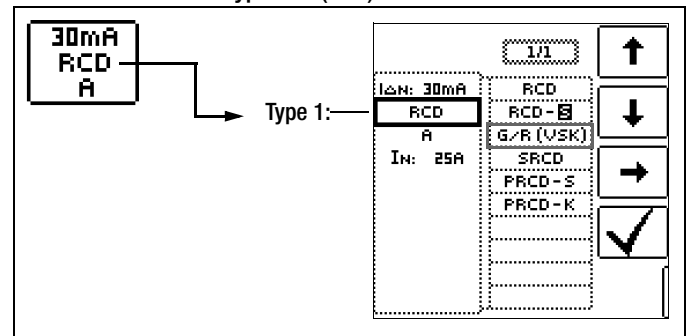

Touch voltage and time to trip can be measured in the **G/R-RCD** switch position.

Note

It must be observed that time to trip for type G RCCBs may be as long as 1000 ms when measurement is made at nominal residual current. Set the limit value correspondingly.

- Then select $5 \times I_{\Delta N}$ in the menu (this is selected automatically for the G/R setting) and repeat the tripping test beginning with the positive half-wave at 0° and the negative half-wave at 180° (full-wave setting). The longer of the two tripping times is decisive regarding the condition of the tested RCCB.

Set parameters

– Start with positive or negative half-wave of the respective full-wave

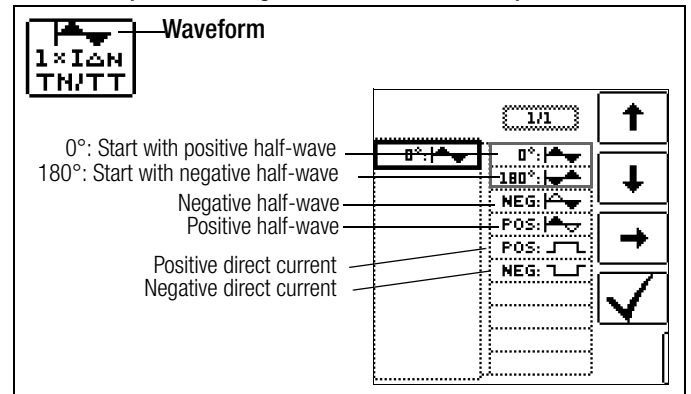

Set the Parameter – 5 Times Nominal Residual Current

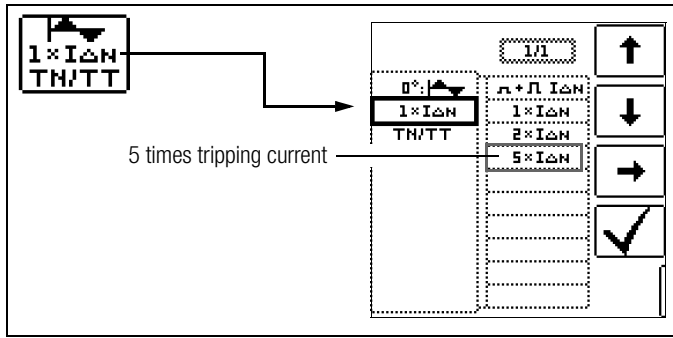

Start the measurement.

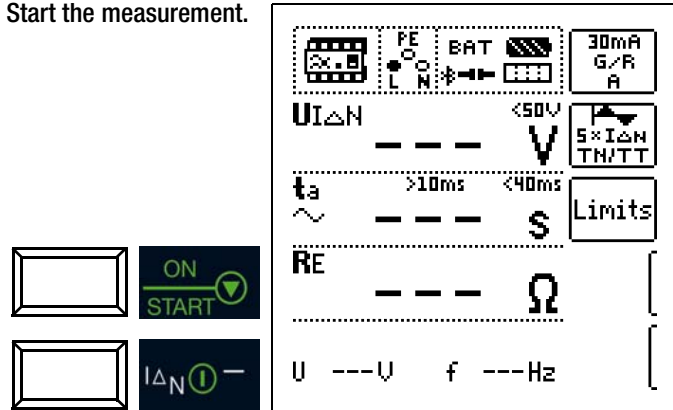

In both cases tripping time must be between **10 ms** (minimum delay time for type G RCCBs!) and **40 ms**.

Type G RCCBs with other nominal residual current values must be tested with the corresponding parameter setting under menu item $I_{\Delta N}$. In this case as well, the limit value must be appropriately adjusted.

Note

The RCD **S** parameter setting for selective RCCBs is not suitable for type G RCCBs.

12.6.8 Testing Residual Current Circuit Breakers in TN-S Systems

General

RCCBs can only be used in TN-S systems (PE and N laid separately). An RCCB would not work in a TN-C system because PE is directly connected to the neutral conductor in the outlet (it doesn't bypass the RCCB). This means that residual current would be returned via the RCCB and would not generate any residual current, which is required in order to trip the RCCB.

As a rule, the display for touch voltage is also 0.1 V, because the nominal residual current of 30 mA together with minimal loop resistance result in a very small voltage value:

$$UI_{\Delta N} = R_E \cdot I_{\Delta N} = 1\Omega \cdot 30mA = 30mV = 0,03V$$

Connection

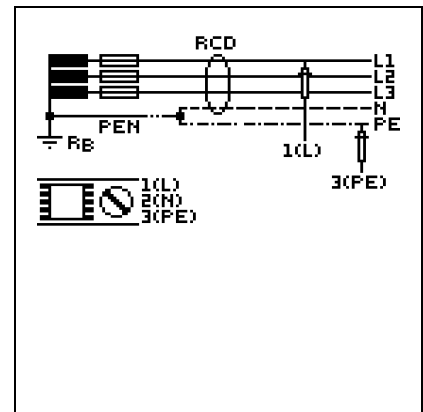

12.7 Notes Concerning Measurement

12.7.1 General

- TN system: due to low protective conductor resistance, measured values for touch voltage $U_{I\Delta N}$ are very low.
- Leakage current upstream from the RCD can influence measurement results and may lead to erroneous tripping.
- If the neutral conductor is used as a probe, the connection between the neutral point and ground must be checked in advance. Any voltage between the neutral conductor and ground can influence the measurement.
- Earth resistance must not exceed the manufacturer's specification.
- Measurement may be influenced by other earthing devices.
- Operating equipment upstream from the RCD, example rotating machines, may significantly increase time to trip.
- Observe the limit values for touch voltage which are stipulated in your country. These may vary depending on the application.
- If inductive power consumers are shut down during the tripping test, resulting voltage peaks may make measurement impossible: measured value display "--". They may also cause the fuses in the test instrument to blow and result in damage to the test instrument.
- Observe shutdown times which depend on the system type during measurement of time to trip as well. The preset limit values are based on valid manufacturing standards for RCDs.

12.7.2 RCDs of Special Design

Special conditions must be taken into consideration for RCDs of special design:

Selective RCDs (identification: **S**):

- In order to assure correct testing of tripping performance, waiting time is required while preloading resulting from the measurement of touch voltage $U_{I\Delta N}$ is allowed to decay. This is indicated by a continuous 30-second display of blinking bars in the t_a field during the RCD $I_{\Delta N}$ time to trip measurement. This waiting time can be circumvented by repeatedly pressing the $I_{\Delta N}$ key.

PRCD-K

Touch voltage measurement is not possible when this type has been selected. Measured values $U_{I\Delta N}$ and R_E are thus not displayed.



Furthermore, PRCD-Ks have an inversely wired protective conductor. Consequently, tripping is already possible as of $0.5 \times I_{\Delta N}$.

RCBO

The RCBO function makes it possible to test RCCBs.





12.7.3 Presettings

Time to Trip Limits, RCD $I_{\Delta N}$, RCD IF + $I_{\Delta N}$

Waveform	$I_{\Delta N}$ Factor	General		Briefly Delayed		Selective	
		$t_a >$	$t_a <$	$t_a >$	$t_a <$	$t_a >$	$t_a <$
Sinusoidal 	0.5	0 ms	300 ms	10 ms	300 ms	130 ms	500 ms
	1	0 ms	300 ms	10 ms	300 ms	130 ms	500 ms
	2	0 ms	150 ms	10 ms	150 ms	60 ms	200 ms
	5	0 ms	40 ms	10 ms	40 ms	50 ms	150 ms
Half-wave 	0.5	0 ms	300 ms	10 ms	300 ms	130 ms	500 ms
	1	0 ms	300 ms	10 ms	300 ms	130 ms	500 ms
DC 	1	0 ms	300 ms	10 ms*	300 ms*	130 ms	500 ms

* Disabled at the test instrument

Tripping Current Limits, RCD $I_{\Delta N}$, RCD IF + $I_{\Delta N}$

		$I_{\Delta} >$	$I_{\Delta} <$
Sinusoidal 		$\frac{1}{2} \times I_{\Delta N}^1$	$1 \times I_{\Delta N}^1$
Half-wave 		$0.35 \times I_{\Delta N}^1$	$1.4 \times I_{\Delta N}^1$
DC 		$\frac{1}{2} \times I_{\Delta N}$	$2 \times I_{\Delta N}$
Type EV, MI DC 		3 mA	6 mA

¹ PRCD-K and SRCD: Half of the respective value of the specified factor is set as the limit value for the no-trip test and the tripping test.

13 ZLOOP – Testing of Breaking Requirements for Overcurrent Protective Devices, Measurement of Line or Loop Impedance and Determination of Short-Circuit Current

13.1 General

Testing of overcurrent protective devices includes visual inspection and measurement. Use the **PROFITEST PRIME** to perform measurements.

Measuring Method

Depending on the utilized type of contacting, the **PROFITEST PRIME** permits measurement of line impedance Z_{L-N} or loop impedance Z_{L-PE} .

Loop impedance Z is measured and short-circuit current I_K is ascertained in order to determine if the breaking requirements for protective devices have been fulfilled.

Loop impedance is the resistance within the current loop (utility station – phase conductor – protective conductor) when a short-circuit to an exposed conductive part occurs (conductive connection between phase conductor and protective conductor). Short-circuit current magnitude is determined by the loop impedance value. Short-circuit current I_K may not fall below a predetermined value set forth by DIN VDE 0100, so that reliable breaking of the protective device (fuse, automatic circuit breaker) is assured.

For this reason, the measured loop impedance value must be less than the maximum allowable value.

Tables containing allowable display values for loop impedance and minimum short-circuit current display values for ampere ratings for various fuses and circuit breakers can be found in the help texts and in section 27 as of page 110. Maximum device error in accordance with VDE 0413 has been taken into consideration in these tables. See also evaluation of the measured values in the following chapters.

At a line voltage of:

120 V (-0%)

230 V (-0%)

400 V (-0%)

690 V (-0%)

test current is ≥ 10 A AC/DC.



If dangerous touch voltage occurs during measurement ($> U_L$), safety shutdown ensues.

The test instrument calculates short-circuit current I_K based on measured loop impedance **ZLOOP** and line voltage. Short-circuit current calculation is made with reference to nominal line voltage for line voltages which lie within the nominal ranges for 120 V, 230 V, 400 V or 690 V systems. If line voltage does not lie within these nominal ranges, the instrument calculates short-circuit current I_K based on prevailing line voltage and measured loop resistance **ZLOOP**.

Display of U_{L-N} (U_N / f_N)

If the measured voltage value lies within a range of $\pm 10\%$ of the respective nominal line voltage of 120 V, 230 V, 400 V or 690 V, the respectively corresponding nominal line voltage is displayed. In the case of measured values outside of the $\pm 10\%$ tolerance, the actual measured value is displayed.

Note

Loop impedance should be measured for each electrical circuit at the farthest point, in order to ascertain maximum loop impedance for the system.

Note

Observe national regulations, e.g. the necessity of conducting measurements without regard for RCCBs in Austria.

3-Phase Connections

Measurement of loop impedance to earth must be performed at all three phase conductors (L1, L2, and L3) for the testing of overcurrent protective devices at three phase outlets.

13.1.1 Measurements with Suppression of RCD Tripping

The test instruments included in the **PROFITEST PRIME** series make it possible to measure loop impedance in TN systems with type A and F RCCBs (10, 30, 100, 300, 500, 1000 mA nominal residual current).

The test instrument generates a direct current to this end, which saturates the RCCB's magnetic circuit.

The test instrument then superimposes a measuring current which only demonstrates half-waves of like polarity. The RCCB is no longer capable of detecting this measuring current, and is consequently not tripped during measurement.

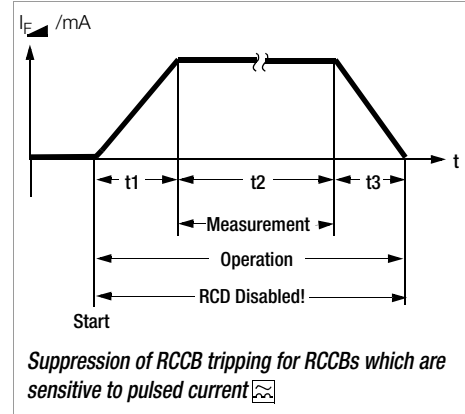

Four-wire measuring cables are used between the instrument and the probes. Cable and probe resistance is automatically compensated for during measurement and does not effect measurement results.

Four-wire measuring cables are used between the instrument and the probes. Cable and probe resistance is automatically compensated for during measurement and does not effect measurement results.

Note

Loop impedance measurement in accordance with the procedure for the suppression of RCCB tripping is only possible with type A and F RCCDs.

Note

Bias Magnetization

Use of probes 1(L), 2(N) and 3(PE) is required for the measurement of bias magnetization.

Further options for suppressing RCD tripping:



Attention!

During loop impedance measurement, it must always be kept in mind that an upstream RCD might be tripped! Appropriate safety precautions should be implemented such as preparing a data backup and possibly shutting down consuming devices prior to testing.

13.1.2 Settings for Calculating Short-Circuit Current – Parameter I_k

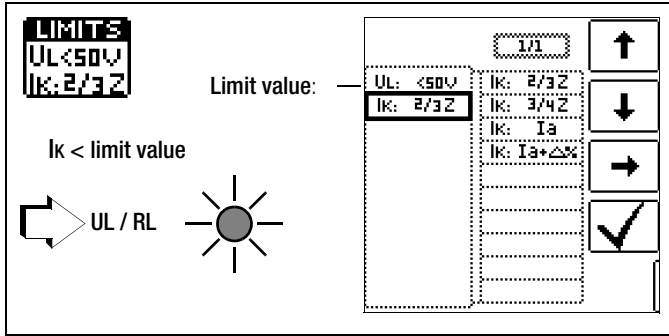

Short-circuit current I_k is used to test shutdown by means of an overcurrent protective device. In order for an overcurrent protective device to be tripped on time, short-circuit current I_k must be greater than tripping current / breaking current I_a (see table 6 in section 27.1). The variants which can be selected with the “Limits” key have the following meanings:

- Ik: I_a** The measured value displayed for I_k is used without any correction to calculate Z_{LOOP} .
- Ik: $I_a + \Delta\%$** The measured value displayed for Z_{LOOP} is corrected by an amount equal to the test instrument’s measuring uncertainty in order to calculate I_k .
- Ik: 2/3 Z** In order to calculate I_k , the measured value displayed for Z_{LOOP} is corrected by an amount corresponding to all possible deviations (these are defined in detail by VDE 0100-60 as $Z_{s(m)} \leq 2/3 \times U_0/I_a$)
- Ik: 3/4 Z** $Z_{s(m)} \leq 3/4 \times U_0/I_a$
- Z** Loop impedance
- Ik** Short-circuit current
- U** Voltage at the test probes, “ U_N ” is displayed if voltage U_{max} deviates from nominal voltage by 10%
- f** Frequency of the applied voltage, “ f_N ” is displayed if frequency f_{max} deviates from nominal frequency by 1%
- I_a** Tripping current (see data sheet for circuit breakers / fuses)
- $\Delta\%$ Test instrument inherent error

13.1.3 Special Case: Measurement without Limit Values

If no limit values are specified, manual evaluation is required.

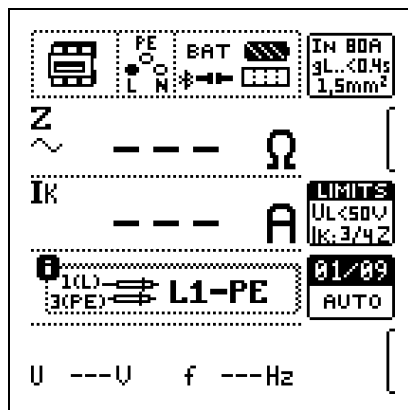

The inspector is prompted to evaluate the measured values himself, and to acknowledge or reject them with the help of the softkeys.

Measurement passed:
✓ key
Measurement failed:
✗ key

The measured value can only be saved after it has been evaluated.

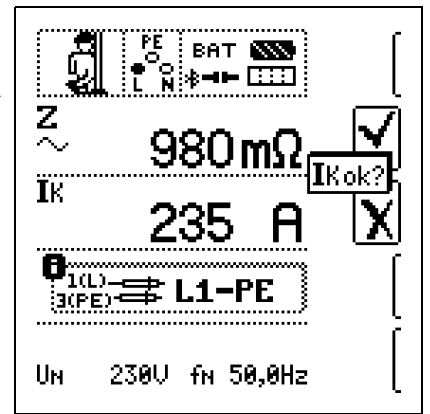

13.1.4 Evaluation of Measured Values

The maximum allowable loop impedance Z_{LOOP} which may be displayed after allowance has been made for maximum operating measurement error (under normal measuring conditions) can be determined with the help of the table in section 27.1.3. Intermediate values can be interpolated.

The maximum allowable nominal current for the protective device (fuse or circuit breaker) for a line voltage of 230 V after allowance has been made for maximum measuring error can be determined with the help of the table in section 27.1.3 based upon measured short-circuit current (corresponds to DIN VDE 0100-600).

13.1.5 Accessing the Table of “Allowable Fuses”

After respective measurement has been performed, allowable fuse types can be displayed by pressing the HELP key.

The table shows maximum allowable nominal current dependent upon fuse type and breaking requirements.

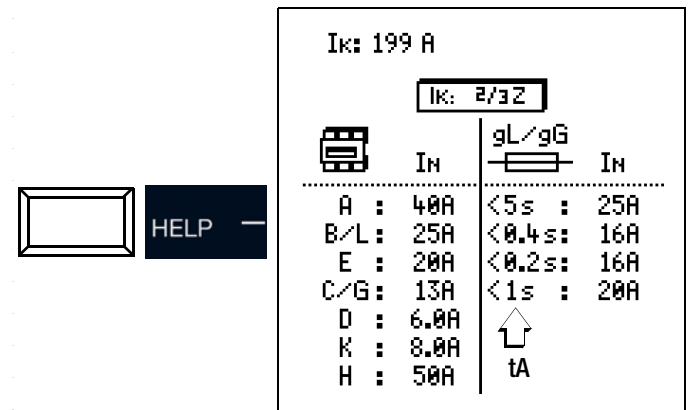

- Key:
- I_a : breaking current
 - I_k : short-circuit current
 - I_N : nominal current
 - t_A : time to trip

Select the measuring function:



13.2.1 Help Function

Illustrations and measurement instructions can be displayed by pressing the **HELP** key. The help function is exited by pressing the **ESC** key.

13.2.2 Parameters

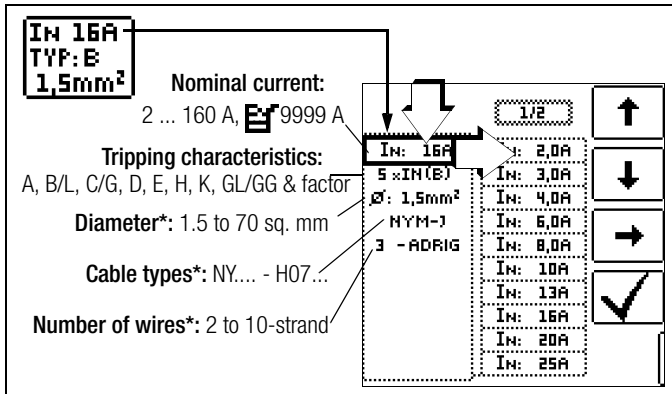

* Parameters which are only used for report generation and do not influence the measurement

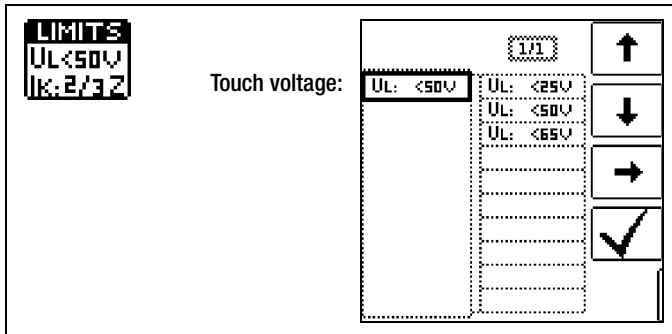

Sinusoidal (full-wave) Setting for circuit without RCD



Parameter **IK** see section 13.1.2 on page 57.

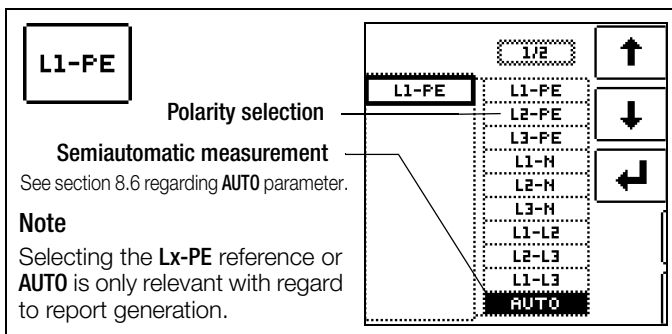

L1-PE

Polarity selection

Semiautomatic measurement
See section 8.6 regarding **AUTO** parameter.

Note
Selecting the **Lx-PE** reference or **AUTO** is only relevant with regard to report generation.

Attention!

During loop impedance measurement, it must always be kept in mind that an upstream RCD might be tripped! Appropriate safety precautions should be implemented such as preparing a data backup and possibly shutting down consuming devices prior to testing.

Connection

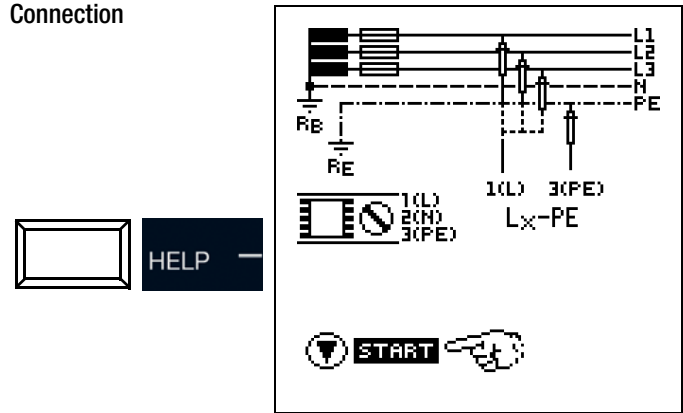

Start the measurement.

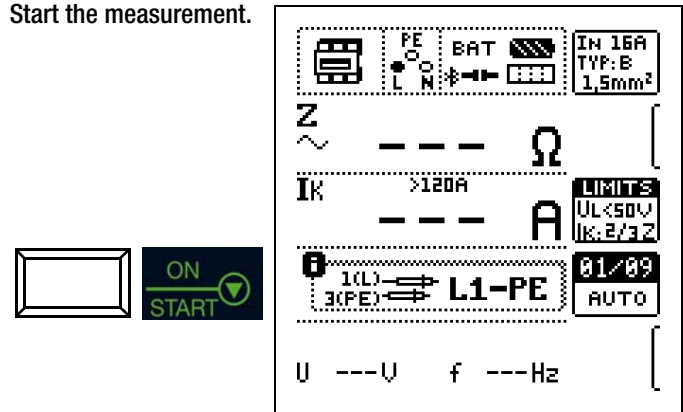

Save the measured value.

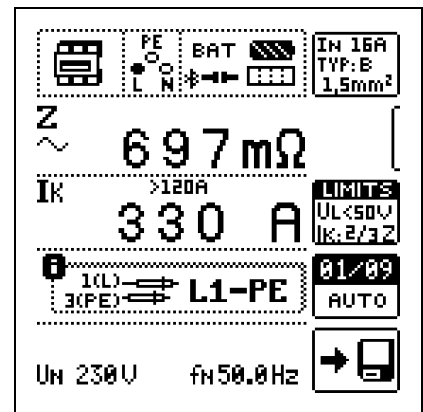

13.2.4 Notes

Evaluation of Measured Values

See section 13.1.4 on page 57.

Displaying the Fuse Table

See section 13.1.5 on page 57.

13.3 ZLOOP DC+ – Measuring Line Impedance



Select the measuring function:



13.3.1 General

Measurement by means of half-waves plus direct current makes it possible to measure loop impedance in systems which are equipped with RCCBs (only for types A and F).

In the case of DC measurement with half-waves, selection can be made from two variants:

- DC-L+ : Minimal bias current but faster measurement as a result
- DC-H+ : Higher bias current providing more reliability with regard to non-tripping of the RCD

13.3.2 Parameters

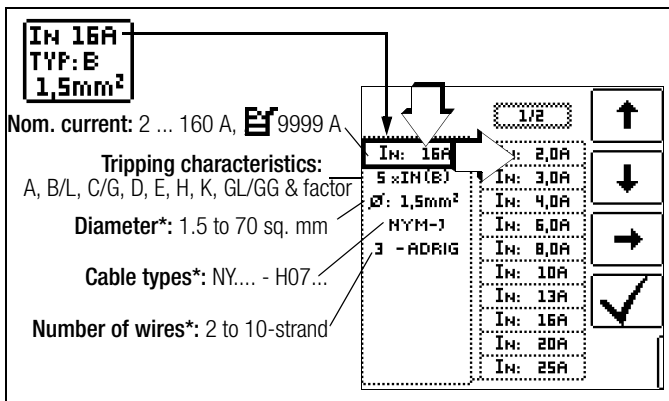

* Parameters which are only used for report generation and do not influence the measurement

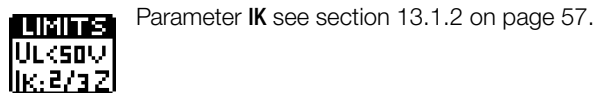
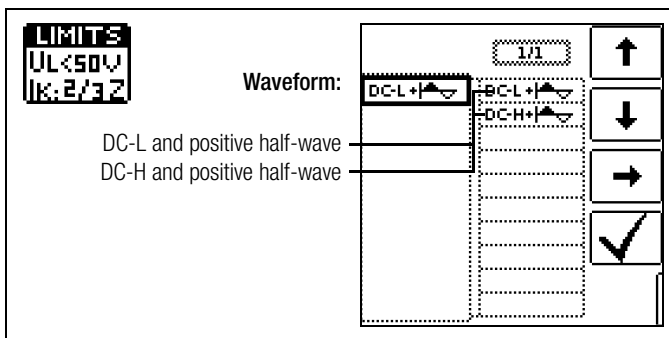

Parameter **Ik** see section 13.1.2 on page 57.

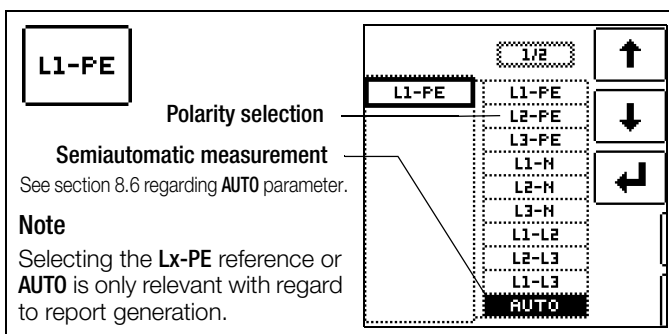

13.3.3 ZLOOP DC+ Measurement

Attention!

During loop impedance measurement, it must always be kept in mind that an upstream RCD might be tripped! Appropriate safety precautions should be implemented such as preparing a data backup and possibly shutting down consuming devices prior to testing.

Connection

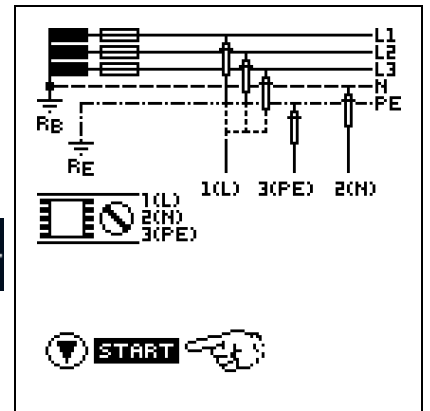

Start the measurement.

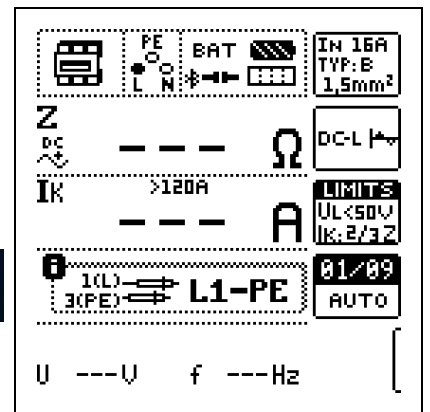

Save the measured value.



13.3.4 Notes

Evaluation of Measured Values

See section 13.1.4 on page 57.

Displaying the Fuse Table

See section 13.1.5 on page 57.

13.4 ZLOOP – Measuring Loop Impedance

Select the measuring function:



ZLOOP AC/DC

13.4.1 General

This function permits the measurement of loop impedance Z_{L-PE} without tripping the RCD (types A, F and B) by means of a combined measuring method.

- 1) Measurement of **Z_{L-N}** with full test current
- 2) Measurement of **R_{N-PE}** with reduced test current

13.4.2 Help Function

Illustrations and measurement instructions can be displayed by pressing the **HELP** key.

The help function is exited by pressing the **ESC** key.

13.4.3 Parameters

* Parameters which are only used for report generation and do not influence the measurement

Parameter **IK** see section 13.1.2 on page 57.

13.4.4 ZLOOP Measurement



Attention!

During loop impedance measurement, it must always be kept in mind that an upstream RCD might be tripped! Appropriate safety precautions should be implemented such as preparing a data backup and possibly shutting down consuming devices prior to testing.

Connection

- Probe 1(L) --> mains L
- Probe 2(N) --> mains PE
- Probe 3(PE) --> mains N

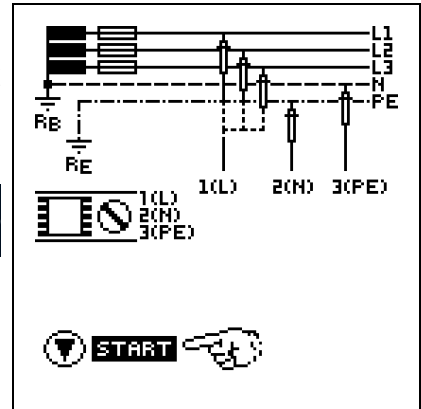

Note

The correct RCD type (above all I_{ΔN}) must be selected before measurement because the RCD will otherwise be tripped during the measuring procedure.

Start the measurement.



Save the measured value.

13.4.5 Notes

Evaluation of Measured Values

See section 13.1.4 on page 57.

Displaying the Fuse Table

See section 13.1.5 on page 57.

13.5 ZLOOP – Measuring Loop Impedance

Select the measuring function:



13.5.1 General

This function permits the measurement of loop impedance Z_{L-PE} without tripping the RCD (types A and F) by using reduced test current depending on the characteristic data of the installed RCD.

13.5.2 Help Function

Illustrations and measurement instructions can be displayed by pressing the **HELP** key.

The help function is exited by pressing the **ESC** key.

13.5.3 Parameters

* Parameters which are only used for report generation and do not influence the measurement

Parameter **IK** see section 13.1.2 on page 57.

Note
Selecting the **Lx-PE** reference or **AUTO** is only relevant with regard to report generation.

13.5.4 ZLOOP Measurement



Attention!

During loop impedance measurement, it must always be kept in mind that an upstream RCD might be tripped! Appropriate safety precautions should be implemented such as preparing a data backup and possibly shutting down consuming devices prior to testing.

Connection

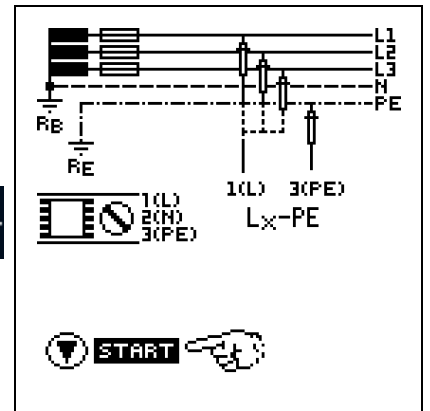

Note

The correct RCD type (above all $I_{\Delta N}$) must be selected before measurement because the RCD will otherwise be tripped during the measuring procedure.

Start the measurement.



Save the measured value.

13.5.5 Notes

Evaluation of Measured Values

See section 13.1.4 on page 57.

Displaying the Fuse Table

See section 13.1.5 on page 57.

14 Ures – Residual Voltage Measurement

Select the measuring function:



Ures

14.1 General

The EN 60204 standard specifies that after switching supply power off, residual voltage must drop to a value of 60 V or less within 5 seconds at all accessible, active components of a machine to which a voltage of greater than 60 V is applied during operation.

Testing for the absence of voltage is performed as follows with the test Instrument by means of a voltage measurement which involves measuring discharge time:

In the case of voltage dips of greater than 5% of momentary line voltage (within 0.7 seconds), the stopwatch is started and momentary undervoltage is displayed as **Ures** after 5 seconds and indicated by the red **UL/RL LED**.

The function is ended after 30 seconds after which Ures and tu data can be deleted and the function can thus be restarted by pressing the ESC key.

Measurement Principle

Time is measured from shutdown of supply power until a voltage threshold is fallen short of.

Measurement is started in the case of voltage dips of more than 5% within 0.7 s.

14.2 Help Function

Illustrations and measurement instructions can be displayed by pressing the **HELP** key.

The help function is exited by pressing the **ESC** key.

14.3 Parameters

Limit Values

The Limits submenu offers the option of configuring the limit values for voltage threshold and discharge time.

If the measured voltage value is greater than the selected voltage threshold when the discharge time limit has been reached, the **UL/RL LED** lights up red.

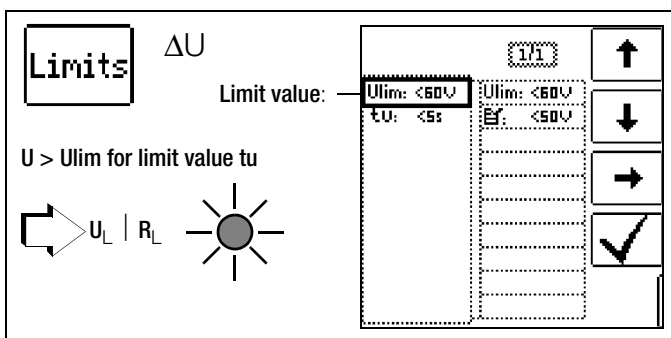

14.4 Ures Measurement

Connection

Probe 1(L)
Probe 3(PE)

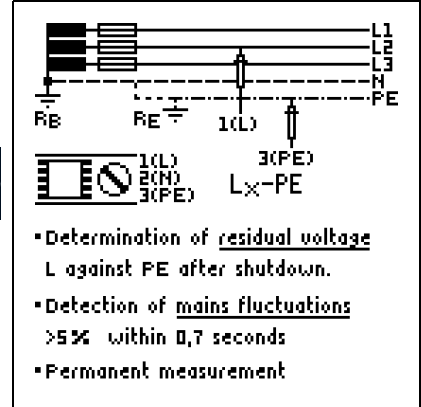

Measurement is continuously active, i.e. voltage dips are automatically detected without pressing a key.

The following measured values are displayed:

- **U**: Momentary voltage at the test probes
- **Ures**: Residual voltage
- **tu**: Discharge time
- **f**: Frequency of the measured voltage

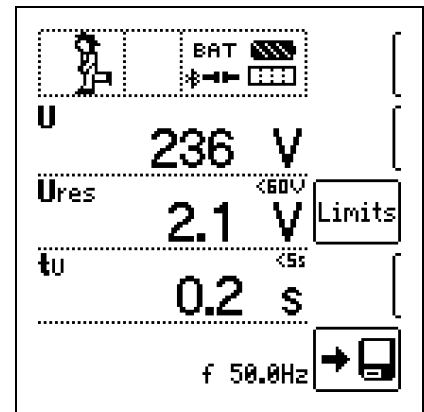

If the voltage threshold is not fallen short of, residual voltage is measured no later than after the selected time has elapsed.

Measurement is ended after 30 s in the event of an error.

Measured values are reset with subsequent restart and aborting of the measurement takes place after pressing the **ESC** key.

The measured value can be saved via softkey after measurement has been performed.

Note

The following limits apply in accordance with DIN EN 60204-1:2006:

- Residual voltage: 60 V
- Discharge time after switching supply power off: 5 s
- Discharge time after exposing conductors: 1 s

15 IMDs – Testing Insulation Monitoring Devices

Select the measuring function:



IMD

15.1 General

Insulation monitoring devices (IMDs), insulation fault locators (IFLs) and earth fault detecting systems (EDS) are used in IT systems, for example in the field of e-mobility for DC charging at charging stations in order to monitor insulation resistance. If the required insulation resistance is fallen short of, a message is read out. The **PROFITEST PRIME** test instrument provides you with the option of testing responsiveness.

Measurement Principle

A single-pole insulation fault is simulated by introducing various resistances between the phase and protective conductors and tripping of the IMD is induced. Time to trip is acquired manually and the response characteristics are evaluated. Test resistances can be set within a range of 15 kΩ to 2.51 MΩ in 65 steps.

15.2 Help Function

Illustrations and measurement instructions can be displayed by pressing the **HELP** key.

The help function is exited by pressing the **ESC** key.

15.3 Parameters

The measurement parameters can be set in the submenus which are described below:

Measuring Procedure (1)

There are two ways to conduct the test:

- **MAN:** Resistance is changed manually by pressing softkeys.
- **AUTO:** Resistance is changed automatically every 2 seconds beginning with **RSTART**.

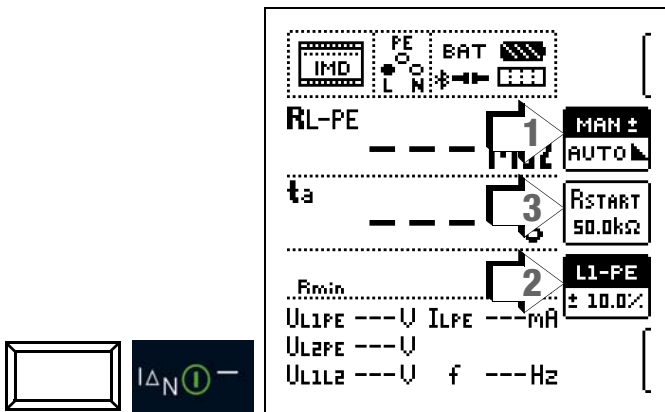

Resistance RSTART (3)

Numerous parameters are available for setting resistance **RSTART**, with which measurement is begun.

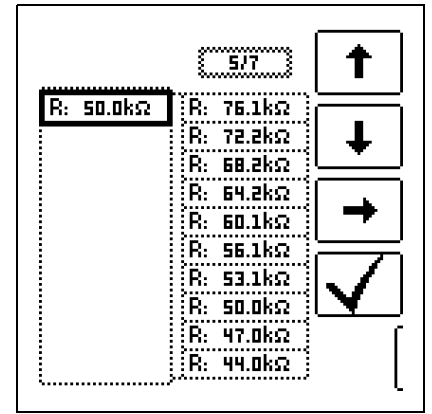

Conductor Relationship / Resistance Range (2)

- **Conductor relationship:** The corresponding conductor relationship can be selected for documentation of the measuring point.
- **Resistance range:** A range of values can be adjusted for testing the display of resistance at the IMD.

The parameter is set as a percentage with reference to the resistance momentarily introduced by the test instrument.

Upper and lower limit values are displayed in the measuring view.

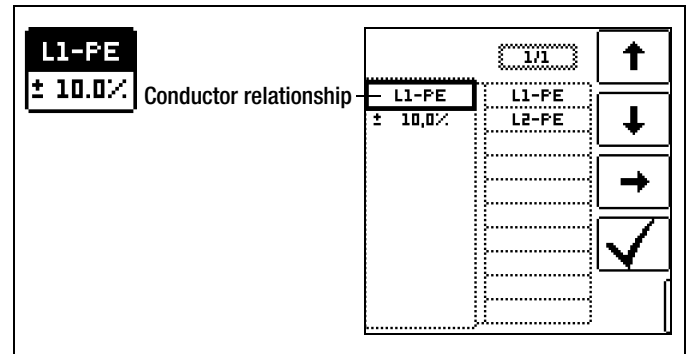

15.4 IMD Measurement

Connection:

L1: probe 1(L)
L2: probe 2(N)
PE: probe 3(PE)

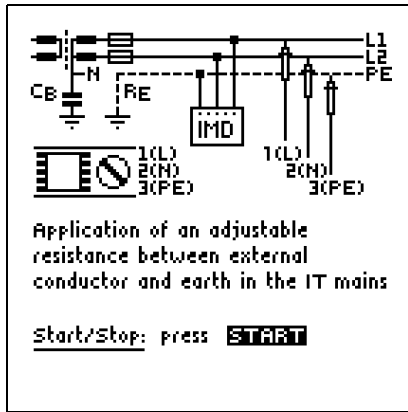

The following measured values are displayed:

- **RL-PE**: active test resistance with upper and lower limit values
- **ta**: response time (time during which the momentary resistance is applied until the measurement is ended)
- **Rmin - Rmax**: status display indicating momentary resistance with reference to the number of possible resistances
- **UL1-PE**: momentary voltage at the test probes between phase conductor L1 and phase conductor PE
- **UL2-PE**: momentary voltage at the test probes between phase conductor L2 and phase conductor PE
- **UL1-L2**: momentary voltage at the test probes between phase conductors L1 and L2
- **IL-PE**: test current flowing through the active resistance
- **f**: frequency of the applied voltage

When selecting test resistance, don't forget that an excessively high test current could damage sensitive system components.

Measuring Procedure

- ⇨ Set the parameters.
- ⇨ Start: Press the **ON/START** key.
- ⇨ A resistance is introduced between the phase and protective conductors and time measurement is started.
- ⇨ **Manual test – MAN + -**: Press the or key to increase or reduce test resistance **RL-PE**
- ⇨ **Automatic test – AUTO**: Resistance is changed automatically.
- ⇨ Tripping time **ta** is restarted each time resistance is changed.
- ⇨ Press **ILN** in order to change the conductor relationship.
- ⇨ In order to end measurement, press **ON/START** as soon as the IMD indicates that insulation resistance has been fallen short of.
- ⇨ Display of measured values
- ⇨ Evaluation prompt: Measurement **OK?**
- ⇨ In case of an evaluation of **NOT OK** the **UL/ RL** LED lights up red.
- ⇨ Press the softkey to save.

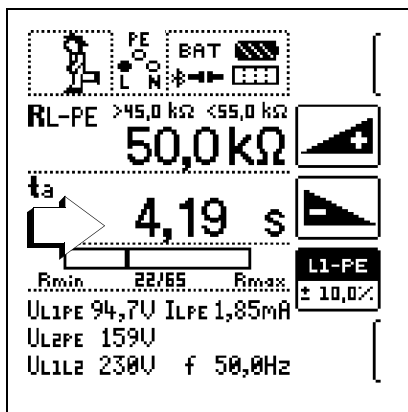

Measurement can be aborted by pressing **ON/START** or **ESC**.

15.5 Evaluation

In order to evaluate the measurement it must be stopped. This applies to manual as well as automatic measurement. Press **ON/START** or **ESC** to this end.

The stopwatch is stopped and the evaluation window appears.

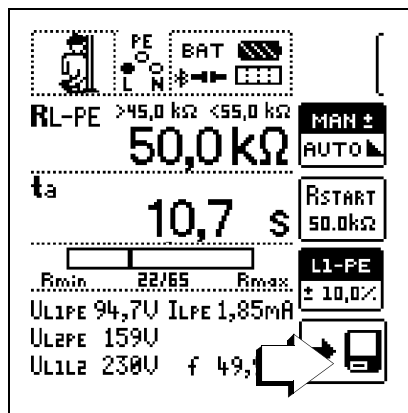
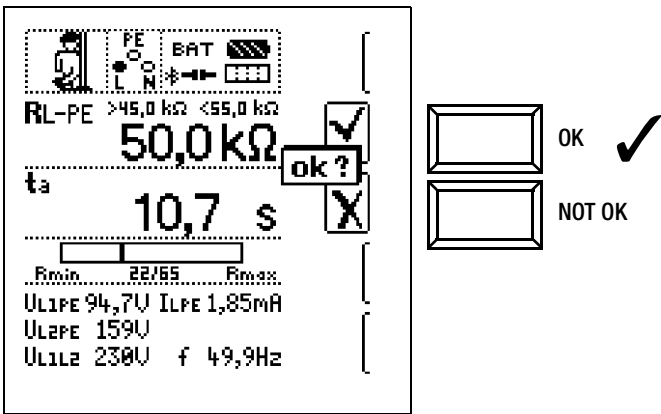

15.6 Retrieving Saved Measured Values

The measured value cannot be saved to memory and included in the test report until it has been evaluated (see also section 23.4).

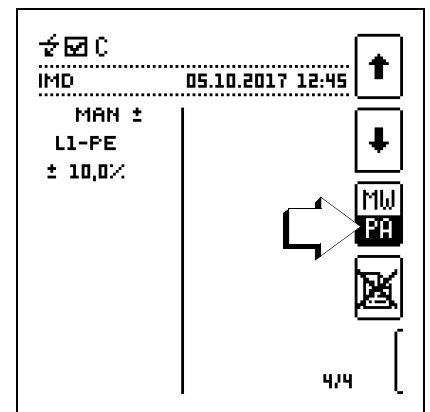
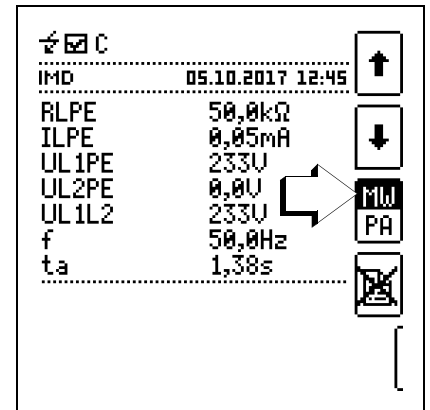

With the help of the key shown at the right (MW: measured value / PA: parameter), the setting parameters can be displayed for this measurement.



16 RCM – Testing of Residual Current Monitoring Devices

Select the measuring function:



RCM

16.1 General

Residual current monitoring devices (RCMs) are used to monitor residual current. They measure and display momentarily flowing current and indicate errors, for example due to defective insulation, in the event that an alarm threshold is fallen short of. As opposed to residual current protective devices, RCMs do not switch off the electrical circuit directly. This is only possible indirectly through the activation of external switchgear. The PROFITEST PRIME test instrument offers the option of testing the response characteristics of RCMs.

Measurement Principle

A test current with constant amperage is applied and the alarm function is checked. When exceeding of the alarm threshold is indicated by the RCM, time measurement for the determination of response time is stopped manually.

Touch voltage is measured by outputting a test current which is below the tripping limit, and by means of subsequent extrapolation up to the nominal residual current value of the RCD.

Response characteristics are then evaluated for report generation.

16.2 Help Function

Illustrations and measurement instructions can be displayed by pressing the **HELP** key.

The help function is exited by pressing the **ESC** key.

16.3 Parameters

The measurement parameters can be set in the submenu which are described below:

Test Parameter

The following characteristic values can be configured for the device under test:

- $I_{\Delta N}$: nominal residual current
- Waveform:
 - Full-wave, 0°
 - Full-wave, 180°
 - Positive half-wave
 - Negative half-wave
 - Positive direct current
 - Negative direct current
- Tripping current factor:
 - $0.5 \cdot I_{\Delta N}$: no-trip test with half nominal residual current (duration: 10 s)
 - $1 \cdot I_{\Delta N}$: tripping test with nominal residual current (duration: 10 s)
- Characteristic, e.g. type AC, type B
- I_N : nominal current
- System type

RCM Parameter

The screenshot shows the RCM Parameter menu with the following settings:

- Nom. residual current: 10 ... 1000 mA
- Waveform: 0°
- X times tripping current: $1/2 \cdot I_{\Delta N}$
- Type: A
- Nominal current: 6 ... 125 A
- System type: TN/TT, IT

The menu also includes a list of nominal residual current values (10mA, 30mA, 100mA, 300mA, 500mA, 1000mA) and a checkmark icon at the bottom right.

Limit Values

The following value can be programmed:

- U_L : maximum permissible touch voltage

If prevailing touch voltage $U_{I_{\Delta N}}$ is greater than limit value U_L , safety shutdown ensues. The **UL/RL LED** lights up red.

The screenshot shows the Limits menu with the following settings:

- Touch voltage: $< 25 \text{ V}, < 50 \text{ V}, < 65 \text{ V}$

The menu also includes a list of limit values (25V, 50V, 65V) and a checkmark icon at the bottom right.

16.4 RCM Measurement

Connection



Measurement with full and half-wave:
 Probe 1(L)
 Probe 3(PE)

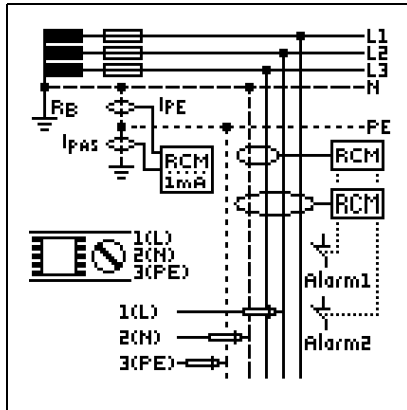

Measurement with direct current:
 Probe 1(L)
 Probe 2(N)
 Probe 3(PE)

Test methods

- 1 If only an RCM has been installed – i.e. no RCDs – the test equipment can be connected between mains and ground.
- 2 Use of an RCM in combination with an RCD:
 - a) Tripping of the RCD is permissible if the test instrument is connected between mains and ground.
 - b) Tripping of the RCD is not permissible if:
 - The test instrument is connected between an upstream conductor and a downstream neutral conductor
 - The test instrument is connected between upstream conductor 1 and downstream conductor 2
 - The test instrument is connected between a conductor and ground with a downstream RCD
 - The test instrument is only connected to additional conductors via the residual current converter
 - The test instrument is connected for the testing of directionally sensitive RCMs in IT systems. Connection must be made at the load side.
- 3 If RCMs are used in combination with electronic devices such as frequency converters, converters without electrical isolation etc., it's generally necessary to test the system at several points, for example upstream from the frequency converter, in the frequency converter's intermediate DC circuit and downstream from the frequency converter.

Measuring Procedure

- ⇨ Set the parameters.
- ⇨ In order to start touch voltage measurement: Press the **ON/START** key.
- The following measured values are displayed: $U_{I\Delta N}$, R_E , U , f
- ⇨ In order to start the no-trigger/trip test: Press the $I_{\Delta N}$ key.
- Test current is applied.
- ⇨ After measurement: Press the $I_{\Delta N}$ key as soon as the RCM is tripped.
- The following measured values are displayed: $U_{I\Delta N}$, t_a , I_{Δ} , R_E , U , f
- ⇨ Respond to the evaluation prompt: "Measurement OK?"
- If the evaluation is "NOT OK": The **UL/ RL LED** lights up red.
- ⇨ Press the corresponding softkey to save your results.

Measure touch voltage.

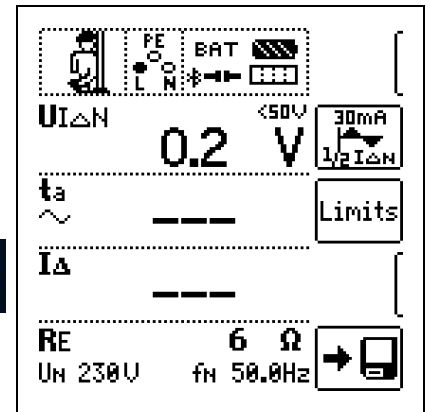

No-trip test with $\frac{1}{2} \times I_{\Delta N}$ and 10 s

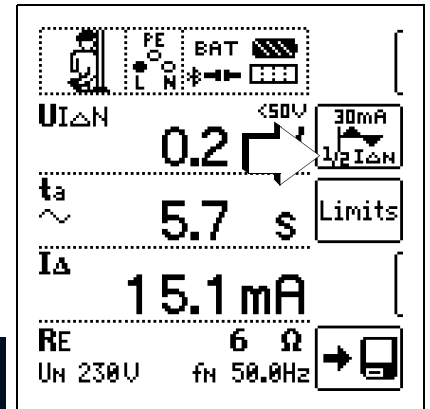

After 10 seconds have elapsed, no residual current may be indicated. The measurement must then be evaluated. In the event that "NOT OK" is selected (in case of false alarm), an error is indicated by the **UL/RL LED** which lights up red.

The measured value cannot be saved to memory and included in the test report until it has been evaluated.

Tripping test with $1 \times I_{\Delta N}$

– Measurement of Signal Response Time (stopwatch function) with Residual Current Generated by the Test Instrument

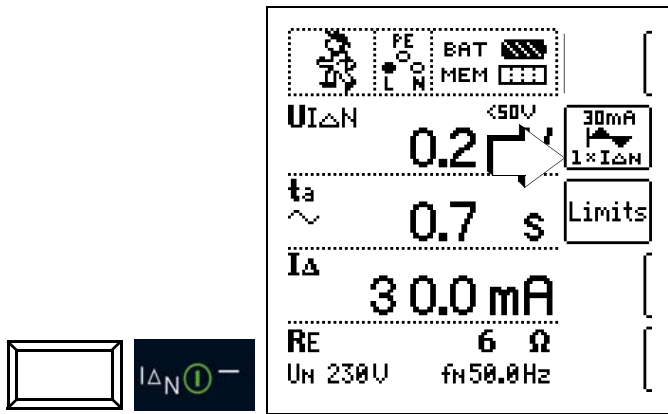

Measurement must be stopped manually by pressing **ON/START** or **I_{ΔN}** immediately after indication of residual current, in order to document tripping time.

In the event that “**NOT OK**” is selected, an error is indicated by the **UL/RL LED** which lights up red.

The measured value cannot be saved to memory and included in the test report until it has been evaluated.

Measurement can be aborted by pressing **ON/START**, **I_{ΔN}** or **ESC**.

The following measured values are displayed:

- $U_{I\Delta N}$: touch voltage relative to nominal residual current
- t_{Δ} : response time (time until the tripping test is stopped manually)
- I_{Δ} : tripping current
- R_E : earth loop resistance
- U : momentary voltage at the test probes, “ U_N ” is displayed if U max. deviates from nominal voltage by 10%
- f : frequency of applied voltage, “ f_N ” is displayed if frequency f max. deviates from nominal frequency by 1%

16.5 Notes Concerning Measurement

- Any voltage between the protective conductor and ground can influence the touch voltage measurement.
- Voltage between the neutral and protective conductors can influence the touch voltage measurement. If the neutral conductor is used as a probe, the connection between the distributor neutral point and ground must be checked before measurement is started.
- Leakage current within the electrical circuit downstream from the RCM may influence the measurement.
- Earth electrode resistance must lie within the limits specified by the manufacturer during the touch voltage measurement.
- Potential fields resulting from other earthing devices may influence the ascertainment of touch voltage.
- Within special ranges, reduced touch voltage limit values apply: 25 V AC or 60 V DC.

17 IL – Leakage Current

Select the measuring function:



17.1 General

The IL measurement permits the measurement of, amongst other values, touch current depending on the utilized type of contacting. At exposed conductive parts which are not connected to the protective conductor, the current must be measured which can flow to earth via the user when touched.

Measurement Principle

The IL measurement is based on the direct measuring method, i.e. current is measured to earth potential via a 2 kΩ resistor. The 3(PE) probe must be connected to the protective conductor system, and the conductive surfaces under test are contacted with the 1(L) probe. TRMS current measurement is performed, and a frequency evaluation is conducted on the basis of a defined frequency response of the measuring setup (see diagram above). A continuous measurement function is used. In the case of interference voltage of greater than 60 V TRMS at probes 1(L) and 3(PE), safety shut-down of the measurement ensues.

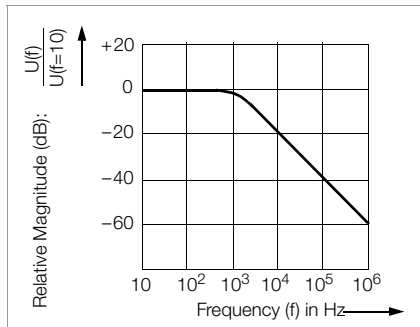

17.2 Help Function

Illustrations and measurement instructions can be displayed by pressing the **HELP** key.

The help function is exited by pressing the **ESC** key.

17.3 Parameters

The measurement parameters can be set in the submenus which are described below:

The following characteristic value can be configured:

“IL” within a range of 0.01 mA to 10.0 mA

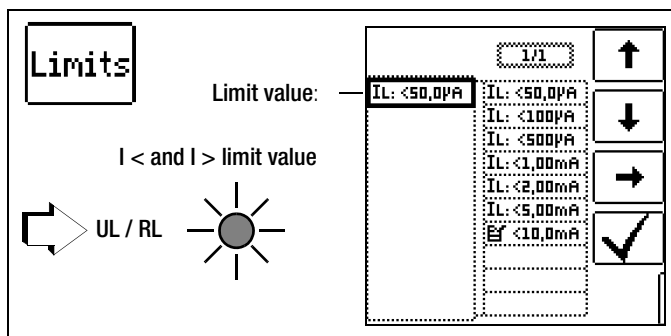

Specifying limit values results in automatic evaluation at the end of the measurement.

17.4 IL Measurement

Connection

Probe 1(L)
Probe 3(PE)

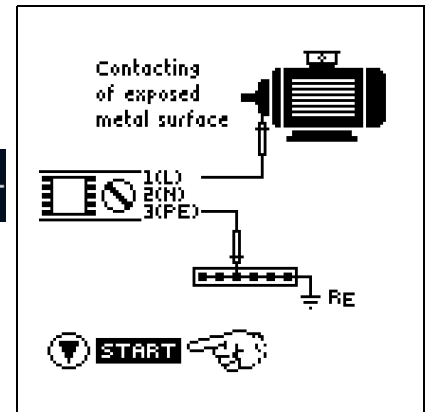

Measuring Procedure

- Set the parameters.
- Connect the probes.
- In order to start current measurement: Press the **ON/START** key.
- The measured values are displayed.
- Press the corresponding softkey to save your results.

Start the measurement.

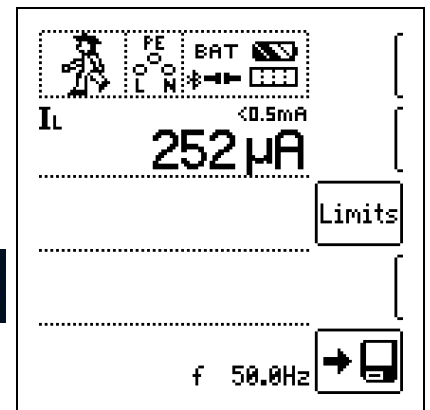

18 I/AMP – Current Measurement with Current Clamp Sensor

Select the measuring function:



18.1 General

Bias, leakage and equalizing current can be measured with the help of special current clamp sensors, which are connected to socket 12. Current clamp sensors with other connectors (4 mm safety plugs) can be connected via the Z506J adapter. In combination with the **PROFITEST PRIME**, the **PROFITEST CLIP** leakage current clamp supports a measuring range of 0.20 mA to 9.99 mA.

18.2 Help Function

Illustrations and measurement instructions can be displayed by pressing the **HELP** key.

The help function is exited by pressing the **ESC** key.

! Attention!

Danger: High-Voltage!

Use only current clamp sensors which are specifically offered as accessories by GMC-I Messtechnik GmbH. Other current clamp sensors might not be terminated with an output load at the secondary side. Dangerously high voltage may endanger the user and the device in such cases.

! Attention!

Maximum input voltage at the test instrument!

Do not measure any currents which are greater than specified for the measuring range of the respective clamp. Input voltage at the test instrument's socket may not exceed 1 V!

! Attention!

Be sure to read and adhere to the **operating instructions** for the current clamp sensors and the safety precautions included therein, especially those regarding the approved **measuring category**.

18.3 Parameters

The transformation ratio parameter must be correspondingly set at the test instrument depending upon the respectively selected measuring range at the current clamp sensor.

Selecting a Measuring Range at the Current Clamp Sensor

Tester Transformation ratio parameter	Clamps			Tester Measuring range	
	PROFIT- EST CLIP	Switch METRA FLEX P300 ¹	Measuring range PROFITEST CLIP		Measuring range METRA FLEX P300
100:1 1 V/10 mA	100 mV/mA	—	0.1 ... 25 mA	—	0.2 ... 9.99 mA
1:1 1 V / A	—	3 A (1 V/A)	—	3 A	5 ... 999 mA
1:10 AM 100 mV / A	—	30 A (100 mV/A)	—	30 A	0.05 ... 10 A
1:100 10 mV / A	—	300 A (10 mV/A)	—	300 A	0.5 ... 100 A

¹ Can be connected via the Z506J adapter

Tester Transformation ratio parameter	Z3512A Clamp ¹		Tester Measuring range
	Switch	Measuring range	
1:1 1 V / A	1 A / x 1	1 A	5 ... 999 mA
1:10 AM 100 mV / A	10 A / x 10	10 A	0.05 ... 10 A
1:100 10 mV / A	100 A / x 100	100 A	0.5 ... 100 A

¹ Can be connected via the Z506J adapter

Limit Values

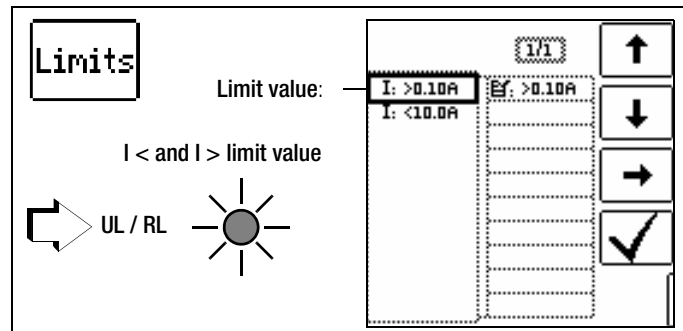

Specifying limit values results in automatic evaluation at the end of the measurement.

18.4 IL/AMP Measurement

Connection

Direct measurement

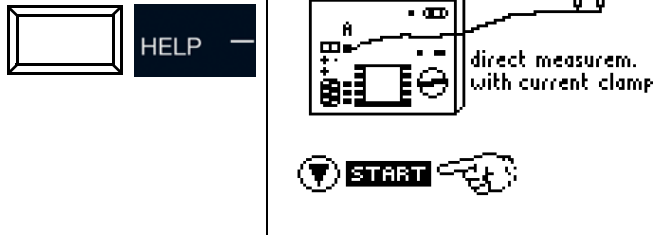

Connection

Differential method

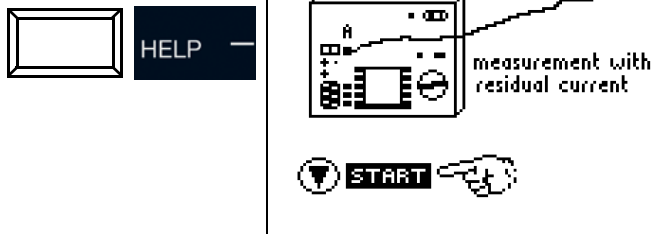

Measuring Procedure

- ⇨ Connect the current clamp sensor.
- ⇨ Set the parameters.
- ⇨ In order to start current clamp measurement:
Press the ON/START key.
- The measured values are displayed.
- ⇨ Press the corresponding softkey to save your results.

Start the measurement.

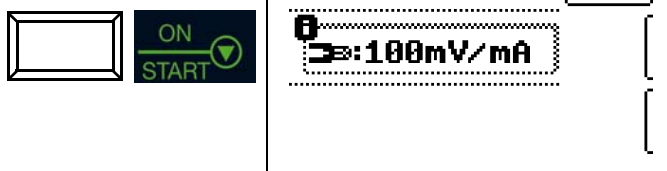

19 T %r.H. – Measurement of Temperature and Atmospheric Humidity

Select the measuring function:



19.1 General

Temperature and relative atmospheric humidity can be measured with the Z506G accessory sensor with the help of this measuring function.



19.2 Help Function

Illustrations and measurement instructions can be displayed by pressing the **HELP** key.

The help function is exited by pressing the **ESC** key.

19.3 Parameters

Temperature can be displayed in either °C or °F by pressing the corresponding softkey.



19.4 T % r.h. Measurement

Connection

The sensor is connected to socket 5: RS 232 port.

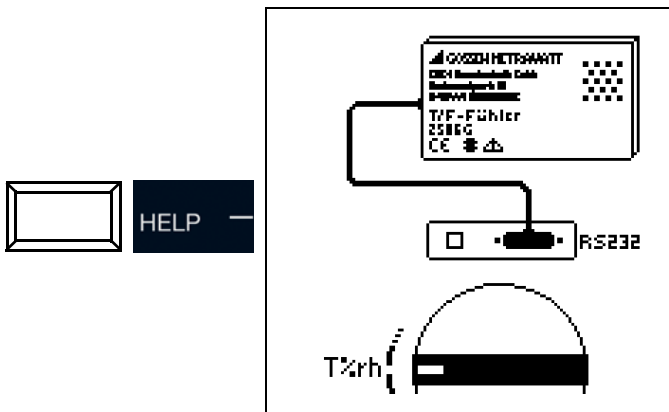

Measuring Procedure

- ⇨ Connect the Z506G T/F sensor.
- The measured values are displayed.
- ⇨ Press the corresponding softkey to save your results.

Save the measured value.

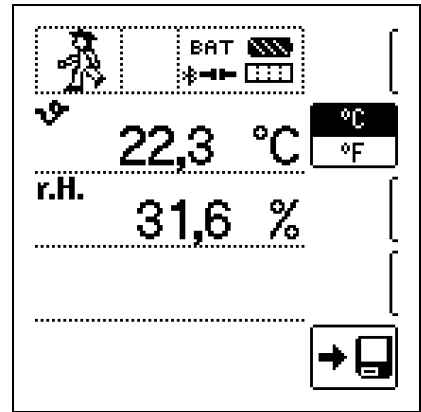

The following measured values are displayed:

- ϑ : temperature [°C/°F]
- r.H.: relative humidity [%]

The following points must be observed:

- Automatic test instrument shutdown is not active in this function.
- The RS 232 port is not intended for communication with the PC.
- Monitoring of the probes' measurement inputs is not active for the basic measuring functions (probes for 1(L), 2(N) and 3(PE) or L1, L2 and L3) with this measuring function. Simultaneous voltage measurement or checking for the absence of voltage is not possible in this function.

20 Extra – Special Functions

Select the EXTRA switch position.



Overview of Special Functions

Softkey	Meaning / Special Function	Section / Page
	Voltage drop measurement Function ΔU	section 20.1 on page 74
	Documentation of charging station tests (checking the operating states of an electric vehicle at charging stations per IEC 61851)	section 20.2 on page 76
	Documentation of fault simulations at PRCDs with the PROFITEST PRCD adapter	section 20.3 on page 77

Selecting Special Functions

The list of special functions is accessed by pressing the uppermost softkey. Select the desired function with the appropriate icon.

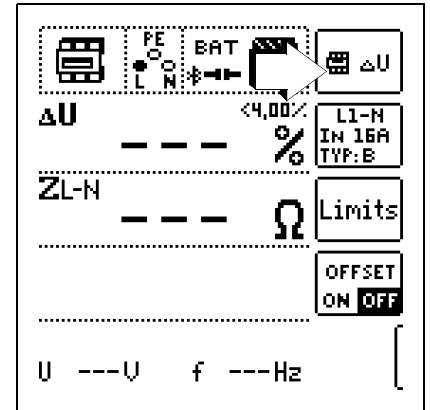

Example: Selecting the PRCD Test

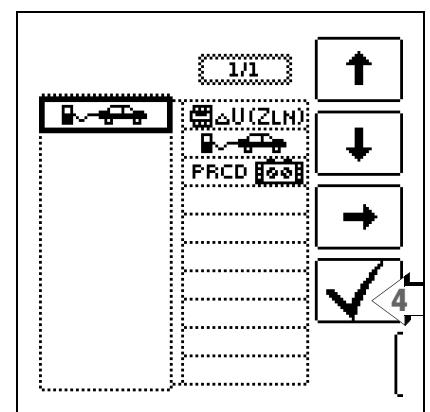
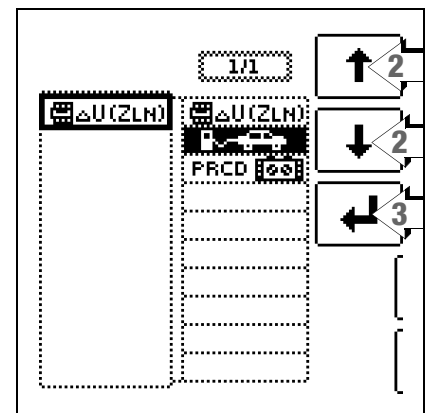
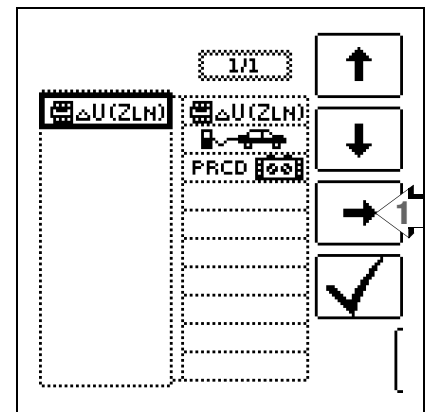

20.1 ΔU – Voltage Drop Measurement

20.1.1 General

In order to assure smooth operation of electrical equipment, it must be assured that an adequately high level of supply voltage is available. Losses in the form of voltage drops at conductors which occur due to prevailing conductor impedances must not be permitted to exceed certain limit values to this end. This makes it necessary to check existing voltage drop from the intersection between the distribution network and the power consuming system up to the consumer.

Measurement Principle

The system is loaded by introducing a resistance and a voltage dip is generated as a result. This mains voltage reduction and the resulting current are measured in order to determine line impedance.

Absolute voltage drop can then be calculated with the following formula:

$$\Delta U_{\text{abs}} = (Z - Z_{\text{OFFSET}}) \cdot I_N \cdot [M]$$

ΔU_{abs} : absolute voltage drop

ZI: line impedance
(phase conductor – neutral conductor, phase conductor – phase conductor)

ZOFFSET: line impedance at the transfer point

I_N : nominal current of the electrical circuit's fuse

In order to obtain relative voltage drop, this is related to prevailing nominal voltage:

$$\Delta U = 100 \cdot \Delta U_{\text{abs}} / U_N, [\%]$$

20.1.2 Help Function

Illustrations and measurement instructions can be displayed by pressing the **HELP** key.

The help function is exited by pressing the **ESC** key.

20.1.3 Parameters

The measurement parameters can be set in the submenu which are described below:

Electrical Circuit Parameter

- Measuring point, e.g. L1-N
- I_N : nominal current of the upstream fuse
- Tripping characteristic, e.g. 5 x I_N (B) (maximum tripping current is additionally specified)
- Cable cross-section
- Type of cable
- Number of wires

Parameters

Note: If nominal current I_N is changed by prevailing ΔU_{OFFSET} , the offset value is automatically adjusted.

Limit Values

The test instrument permits the display of exceeded limit values. If measured voltage drop is greater than the selected limit value, the UL/R LED lights up red.

Various fixed parameters are available for settings, which are cited with reference to various standards. The list can be extended with the help of the **EF** editing function. This function is made available as soon as the cursor is located in the parameter selection column.

Limit Values

DIN Limit value per DIN 18015-1: $\Delta U < 3\%$
between the measuring device and the consuming device

VDE Limit value per DIN VDE 0100-520:
 $\Delta U \leq 3\%$ for lighting systems
 $\Delta U \leq 5\%$ for other electrical consuming devices
in each case between the distribution network (public supply network) and the consuming device
(adjustable up to 10% in this case)

20.1.4 ZOFFSET Measurement

General

The ZOFFSET function offers the option of saving the line impedance of the transfer point as an offset value and taking it into account for subsequent voltage drop measurements.

Connection

Probe 1(L)
Probe 3(PE)

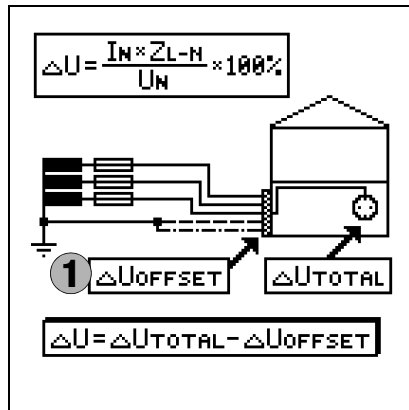

Measuring Procedure

- Activate the ZOFFSET function by pressing the corresponding softkey.



- The following values are displayed: $\Delta U_{\text{OFFSET}} 0.00\%$
 $Z_{\text{OFFSET}} 0.00 \Omega$
- Connect the test probes to the transfer point (measuring device / meter).
- Start measurement by pressing the $I_{\Delta N}$ key.

First of all, an intermittent acoustic warning is generated and a blinking message appears, in order to prevent inadvertent deletion of a previously saved offset value.

- Start offset measurement by pressing the triggering key once again or abort offset measurement by pressing the ON/START key (in this case ESC).
- Z_{OFFSET} is measured and ΔU_{OFFSET} is calculated.
- The values are displayed.

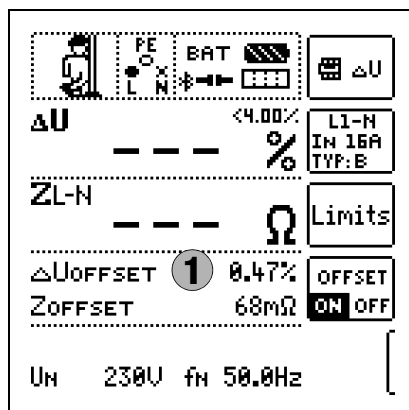

The following points must be observed:

- If nominal current I_N changes, ΔU_{OFFSET} is adjusted automatically.
- The ascertained Z_{OFFSET} value is deleted when the function is deactivated.
- If an error message appears, the last acquired, valid value is retained.
- As a result of the utilized 4-wire technology, resistance of the probe cables does not have to be calculated into the measurement results.

20.1.5 ΔU Measurement

Connection

Probe 1(L)
Probe 3(PE)

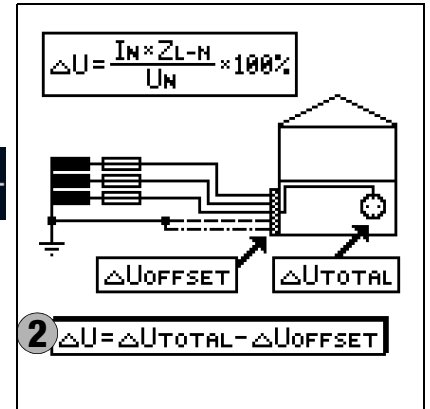

Measuring Procedure

- Connect the test probes.
- Set the parameters.
- In order to start the voltage drop measurement: Press the ON/START key.
- If measurement has to be aborted: Press ON/START or ESC.
- Measurement is performed.
- The measured values are displayed.
- Press the corresponding softkey to save your results.

Start measurement with OFFSET.

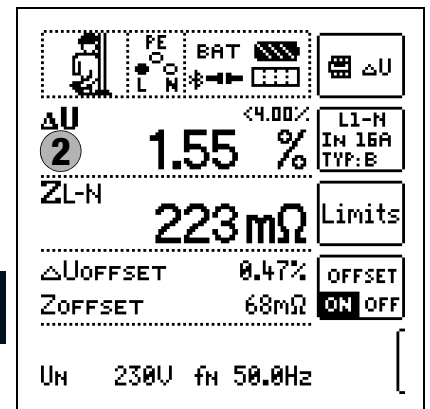

The following measured values are displayed:

- ΔU : relative voltage drop
- Z : line impedance
- U : momentary voltage at the test probes, " U_N " is displayed if voltage U max. deviates from nominal voltage by 10%
- f : frequency of the applied voltage, " f_N " is displayed if frequency f max. deviates from nominal frequency by 1%

With activated ZOFFSET function:

- ΔU_{OFFSET} : relative voltage drop at the transfer point
- Z_{OFFSET} : line impedance at the transfer point

20.2 E-Mobility – Checking the Operating States of an Electric Vehicle at Charging Stations per IEC 61851

A charging station is a facility designed to charge electric vehicles in accordance with IEC 61851, and is equipped with essential elements including a plug connector, conductor protection, an RCD, a circuit breaker and a safety communication device (PWM). Depending on where it's used, other function modules may be added, for example for mains connection and metering. An inspection of the charging station is performed with the PRO-TYP II (Z525A) test adapter.



PRO-TYP II (Z525A)

Selecting the Adapter (test box)

After selecting charging station in the EXTRA menu, the adapter can be chosen by pressing the charging station symbol in the upper right-hand corner. The EXTRA selection menu is accessed by pressing this key once again.

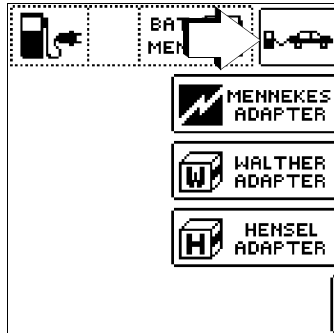

Simulation of Operating Statuses per IEC 61851 with the MENNEKES Test Box (statuses A through E)

The MENNEKES test box is used exclusively to simulate the various operating statuses of a fictitious electric vehicle connected to a charging station. Settings for the simulated operating statuses can be found in the operating instructions for the test box.

The simulated operating statuses can be saved to the **test instrument** as a visual inspection and documented in the report generating program.

Select the respective status to be checked with the **SELECT STATUS** key at the test instrument.

Status A – charging cable connected to charging point only

- CP signal is activated
- Voltage between PE and CP is 12 V

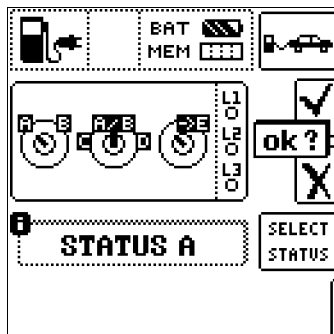

Status B – charging cable connected to charging point and vehicle

- Charging cable is locked into place at the charging point and the vehicle
- Vehicle is not yet ready for charging
- Voltage between PE and CP: +9 V / -12 V

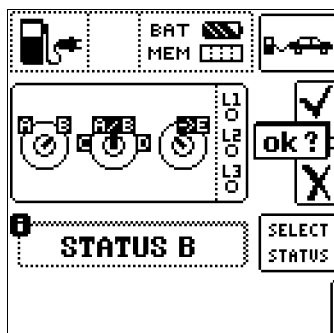

Status C – non-gassing vehicle detected

- Vehicle is ready for charging / power is connected
- Voltage between PE and CP: +6 V / -12 V

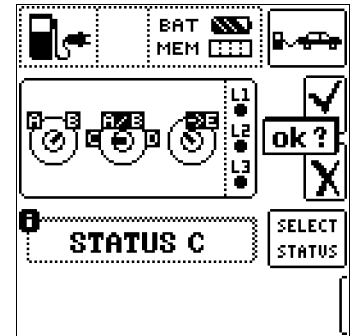

Status D – gassing vehicle detected

- Vehicle is ready for charging / power is connected
- Voltage between PE and CP: +3 V / -12 V

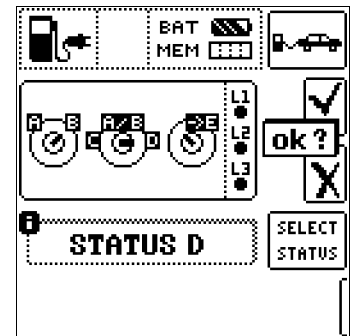

Status E – cable is damaged

- Short-circuit between PE and CP
- Charging cable is unlocked at the charging point
- Voltage between PE and CP is +0 V

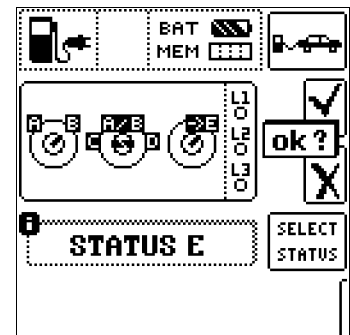

Semi-Automatic Changing of Operating Statuses

As an alternative to manual status changing via the parameters menu for the **SELECT STATUS** softkey at the test instrument, quick and convenient switching amongst the statuses is also possible. The **AUTO** status parameter has to be selected to this end. After responding to the visual inspection prompt and saving the results, automatic switching to the next status ensues – the 01/05 key display corresponds to A/E (01 = A, 02 = B, 03 = C, 04 = D, 05 = E).

Given statuses can be skipped by pressing the $I_{\Delta N}$ key at the test instrument or the corresponding key on the optional I-SK4/12 probe.

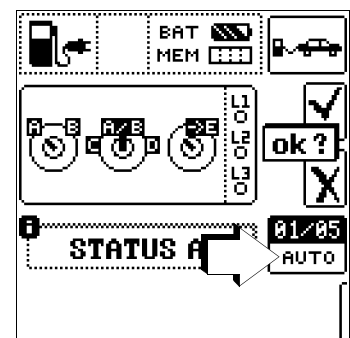

20.3 PRCD – Test Sequences for Documenting Fault Simulations at PRCDs with the PROFITEST PRCD Adapter

The following functions are possible after connecting the test instrument to the PROFITEST PRCD test adapter:

- There are three preset test sequences:
 - PRCD-S (single-phase / 3-pole)
 - PRCD-K (single-phase / 3-pole)
 - PRCD-S (3-phase / 5-pole)
- The test instrument runs through all test steps semi-automatically:
 - Single-phase PRCDs:
 - PRCD-S: 11 test steps
 - PRCD-K: 4 test steps
 - 3-phase PRCDs:
 - PRCD-S: 18 test steps
- Each test step is evaluated and assessed by the user (go/no-go) for later documentation.
- Measurement of the PRCD's protective conductor resistance using the test instrument's **RLo** function. Please note that the protective conductor measurement is a modified RLO measurement with ramp sequence for PRCDs (see section 10.1.7).
- Measurement of the PRCD's insulation resistance using the test instrument's **Riso** function (see section 11).
- Tripping test with nominal residual current using the test instrument's $I_{F\Delta N}$ function (see section 12.3).
- Measurement of time to trip using the test instrument's $I_{\Delta N}$ function (see section 12.4).
- Varistor test with PRCD-K: measurement via ISO ramp (see section 11.2).



Attention!

Before connecting the PROFITEST PRIME to the PRCD adapter, be sure to read the operating instructions for the PROFITEST PRCD.

20.3.1 Selecting the PRCD to be Tested

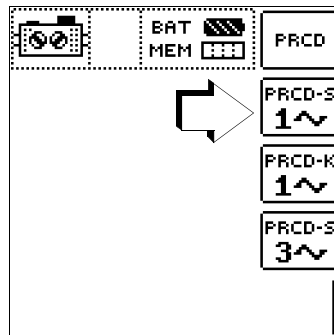

After selecting PRCD in the EXTRA menu, the desired adapter can be chosen by pressing the adapter symbol in the upper right-hand area. The EXTRA selection menu is accessed by pressing this key once again.

20.3.2 Parameter Settings

Meanings of Symbols for the Respective Fault Simulations

Switch Position	Symbol at PROFITEST PRIME		Significance of Symbol
PROFITEST PRCD	Parameter Setting.	Menu Display	
	ON	1~ON	Single-phase PRCD activated
	ON	3~ON	3-phase PRCD activated
	BREAK Lx		Interrupted phase
	Lx <-> PE Lx <-> N		Wires reversed between phase conductor and PE or neutral conductor
PE-U _{EXT}	Uext -> PE	PE-U _{EXT}	PE to phase
	PROBE		Contact the ON key at the PRCD with the probe
	PRCD-Ip		Protective conductor current measurement with current clamp transformer
—	AUTO	AUTO	Semi-automatic change of fault simulations

PRCD-S Single-Phase Parameter – Parameter 11 = 11 Test Steps

Together with the required intermediate steps for PRCD activation (= ON) the parameters for fault simulations represent the 11 possible test steps:

Interrupt (BREAK...), reversed conductors (L1 <-> PE), PE to phase (Uext -> PE), contact with the ON key, protective conductor current measurement (figure below: PRCD-Ip).

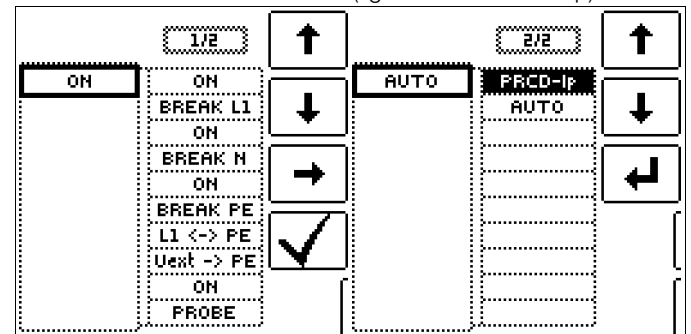

PRCD-S 3-Phase Parameter – Parameter 18 = 18 Test Steps

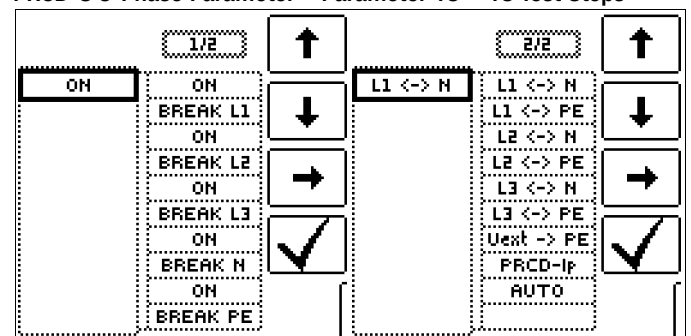

PRCD-K Single-Phase Parameter – Parameter 4 = 4 Test Steps

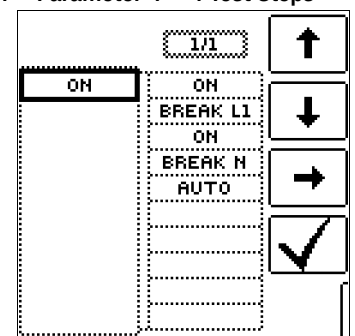

20.3.3 PRCD-S Test Sequence (single-phase) – 11 Test Steps

Selection Examples

Simulation of Interruption (steps 1 to 6)

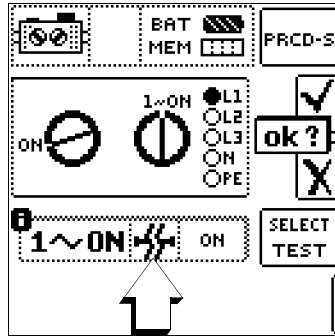

Reversed Conductor Simulation (step 7)

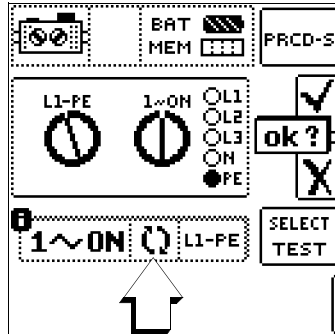

Simulation of PE to Phase (step 8)

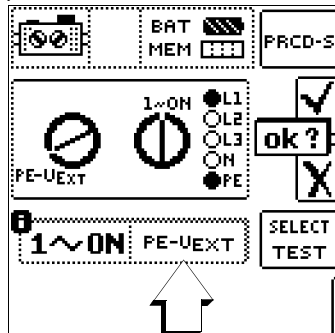

Contact ON Key at PRCD with Probe (step 10)

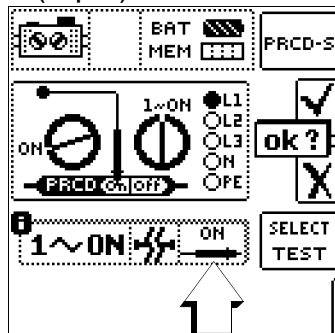

Measurement of Protective Conductor Current with a Current Clamp Transformer (step 11)

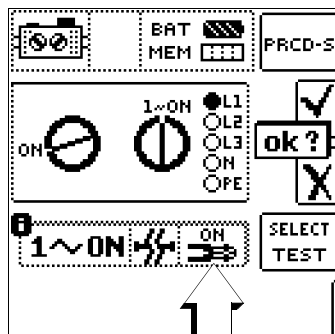

20.3.4 PRCD-S Test Sequence (3-phase) – 18 Test Steps

Selection Examples

Simulation of Interruption (steps 1 to 10)

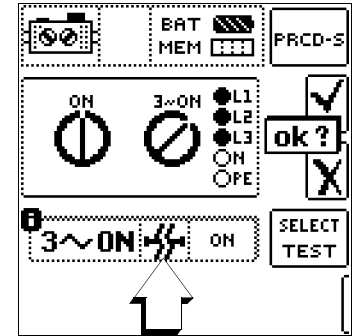

Reversed Conductor Simulation (steps 11 to 16)

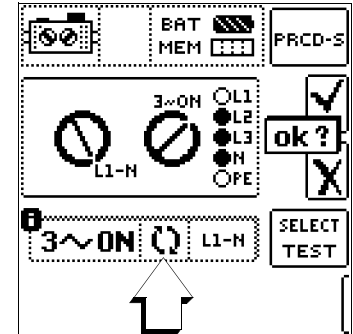

Simulation of PE to Phase (step 17)

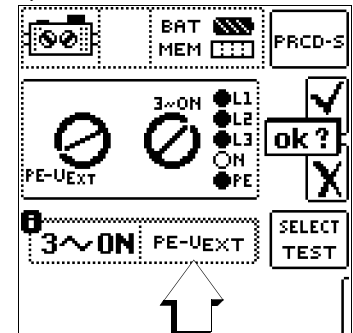

Measurement of Protective Conductor Current with a Current Clamp Transformer (step 18)

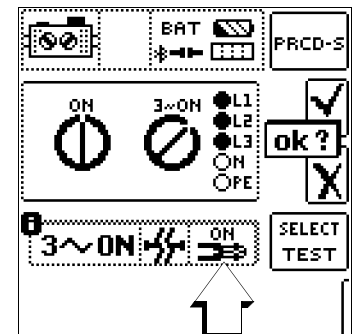

Semi-Automatic Changing of Operating Statuses

As an alternative to manual status changing via the parameters menu at the test instrument, quick and convenient switching amongst the fault simulations is also possible. The AUTO status parameter has to be selected to this end. After responding to the visual inspection prompt and saving the results, automatic switching to the next fault simulation ensues. Given fault simulations can be skipped by pressing the I_{AN} key at the test instrument or the corresponding key on the optional I-SK4/12 probe.

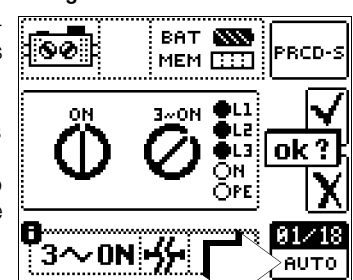

21 HV AC – Testing for Dielectric Strength (with PROFITEST PRIME AC)

Select the measuring function:



Caution: High-Voltage!

It's absolutely essential to observe the safety precautions in section 3.1 and section 3.2, as well as the checklist on page 13.

21.1 General

The electrical equipment of the machine under test must withstand a test voltage of twice its own rated voltage value or 1000 V~ (whichever is largest) applied between the conductors of all circuits and the protective conductor system for a period of at least 1 second. The test voltage must have the same frequency as the electrical supply network, and must be generated by a transformer with a minimum power rating of 500 VA. The standard sequence, continuous operation and pulse control modes are available for various testing tasks.



Attention!

The test instrument itself must not be used as a device under test when testing for dielectric strength with HV AC.



Attention!

Before beginning work, the test instrument, the high voltage cables, the high-voltage pistols and accessories must be inspected to assure that they are in flawless condition (see also section 3.2 on page 13).



Attention!

Warning lamps (Z506B signal lamp combination) may possibly fail (for example due to damaged lamp inserts or connector cables).

Therefore, the inspector always has to ensure that no other persons are present in the potential danger zone of the test to be performed or of the DUT (e. g. by means of appropriate shutoff measures).



Attention!

Monitoring the Measurement Inputs

Monitoring of the probes' measurement inputs is not active for the basic measuring functions (probes for 1(L), 2(N) and 3(PE) or L1, L2 and L3) with the HV AC measuring function for testing dielectric strength.

Simultaneous voltage measurement or checking for the absence of voltage is not possible in this function.

Before conducting the high-voltage test, make sure that the electrical circuit to be tested or the respective system components are voltage-free (measuring function U – measuring voltage and frequency, see section 9)!



Note

Checking the Measurement Cables

If measurement isn't started with the high-voltage module in the standby state (test instrument ready for activation, red signal lamp lit up) although both high-voltage pistols have been activated, one of the measurement cables is probably interrupted.

Measurement Principle

Testing for dielectric strength is conducted by outputting an alternating voltage of 200 V to 2.5 kV at line frequency (primarily sinusoidal oscillation with a frequency of 45 to 65 Hz). In accordance with DIN EN 61439-1, test current is at least 100 mA, and short-circuit current which must be supplied by the high-voltage transformer (at least 500 VA nominal power) is 200 mA.

In order to protect the device under test, current limiting and rise time until the selected test voltage is reached can be selected.

In the event of short-circuiting or breakdown due to an insulation defect at the device under test, measurement is stopped when the selected shutdown current has been reached and achieved test voltage is displayed.

The following operating modes can be selected:

- Standard sequence for standards-compliant testing for dielectric strength
- Continuous operation for long-term testing and troubleshooting
- Pulse control mode for troubleshooting

Applications

The high-voltage module for the PROFITEST PRIME AC is intended for quick and safe performance of testing for dielectric strength at electrical and electronic equipment and systems in machines in accordance with DIN VDE 0113/EN 60204-1.

All of the values required for approval reports can be measured with this instrument.

21.1.1 Help Function

Illustrations and measurement instructions can be displayed by pressing the **HELP** key.

The help function is exited by pressing the **ESC** key.

21.2 Connection

See section 5.2 on page 17 regarding connection of the signal lamp combination, the emergency off switch and the high-voltage pistols.

Optical Indication – HV TEST LED

When lit up, the red caution LED above the key switch indicates that the HV switch position has been selected and that the **HV TEST** connector panel is active, and that HV test voltage is applied to the sockets for the high-voltage pistols.

- Continuous illumination: Ready for operation and for activation
- Blinking: Active testing, high-voltage is present



Attention!

Detection of interference voltage at probes 1(L), 2(N) and (PE) is not possible in the **HV** switch position.

Optical Indication – SIGNAL PROFITEST PRIME AC

The signal lamp combination which has to be connected (accessory: Z506B) indicates the following states:

- **Green:** no high voltage present, LCD:
- **Red:** high voltage ready, danger! LCD:

Acoustic Indication – Periodic Acoustic Warning

Acoustic signaling takes place during the test sequence – when high-voltage is present. The repetitive acoustic sequence is higher pitched in the pulse control mode than during the other two voltage sequences.

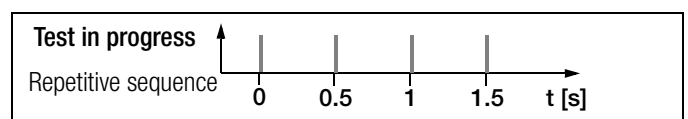

21.3 Parameters

The desired voltage sequence is entered here, followed by the respective parameters.

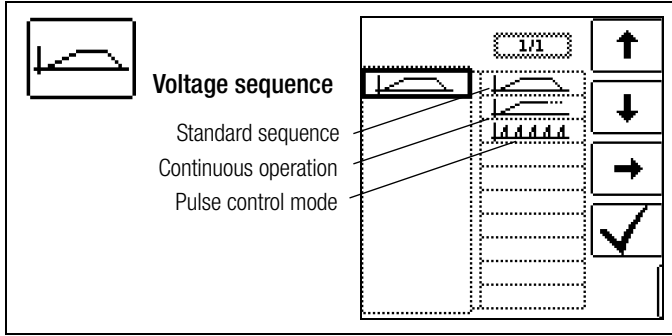

Standard Sequence

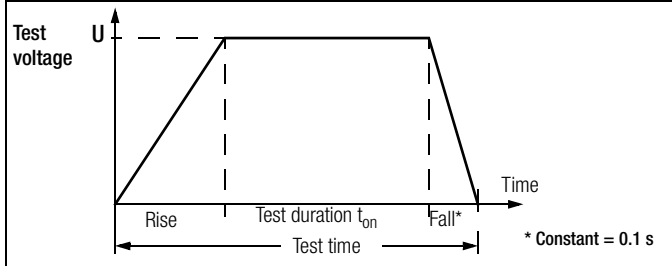

After selected rise time t_{\uparrow} has elapsed, specified U is applied until the selected test duration t_{on} has elapsed.

Shutdown current I_{LM} can be adjusted within a range of 1 to 200 mA. If this value is exceeded, test voltage is switched off within 0.5 ms.

Continuous Operation

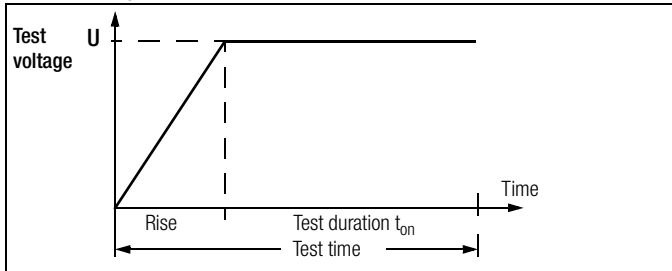

After selected rise time t_{\uparrow} has elapsed, specified U is applied until the triggers at the high-voltage pistols are released.

Continuous operation ">>>" is set as test duration t_{on} .

Shutdown current I_{LM} can be adjusted within a range of 1 to 200 mA. If this value is exceeded, test voltage is switched off within 0.5 ms.

Pulse Control Mode

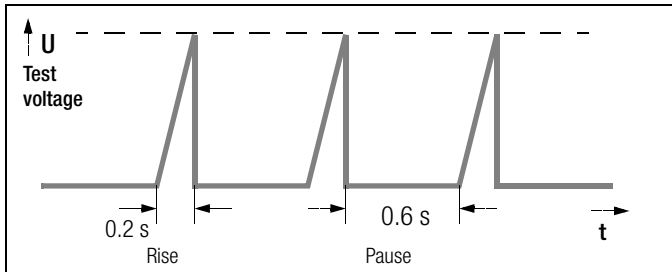

We recommend selecting the pulse control mode for troubleshooting purposes (arc-over location).

Continuous operation ">>>" is set as test duration t_{on} .

Shutdown current I_{LM} is permanently set to roughly 125 mA in the pulse control mode. If this value is exceeded, test voltage is switched off within 0.5 ms. After approximately 0.6 seconds, test voltage is cyclically increased from 0 V to the selected final value within a period of $t_{\uparrow} = 0.2$ s, or is switched back when shutdown current is reached.

2500V
 t_{\uparrow} 1,0s
 t_{on} 5,0s

Test voltage
Rise time
Test duration

U: 2500V
 t_{\uparrow} : 1,0s
 t_{on} : 5,0s

U: 200V
U: 250V
U: 500V
U: 750V
U: 1000V
U: 1500V
U: 2000V
U: 2500V
Ef: 1250V

Example: (maximum) presetting for the standard sequence

Test voltage U: Test voltage level
Entry limits: 200 V ... 2500 V

Rise time t_{\uparrow} : Time during which test voltage is increased to the selected value
Entry limits: 0.1 s ... 99.9 s
(does not apply to pulse control mode which has a fixed setting of 0.2 s)

Test duration t_{on} : Time during which test voltage is applied
Entry limits: 1 s ... 120 s
(does not apply to the continuous operation function or the pulse control mode for which continuous measurement " $t_{on} \gg \gg$ " is selected)

I_{LM}
10mA

Maximum current

I: 10,0mA
I: 1,0mA
I: 10,0mA
I: 50,0mA
I: 100mA
I: 150mA
I: 200mA

I_{LM}: Max. permissible current before high-voltage is switched off
Entry limits: 1 ... 200 mA
(does not apply to pulse control mode)

A list of all entry limits and default values is included in the section 25.

2-Pole Measurement with Fast and Semiautomatic Polarity Reversal

L1-PE

L1-PE
L2-PE
L3-PE
AUTO

HV/AC
BAT

U: 2500V
 t_{\uparrow} : 1,0s
 t_{on} : 5,0s

I: 10,0mA
I_{LM}
10,0mA

U_{max}: 01/03
L1-PE

SIGNAL OFF KEY

For details on fast or semiautomatic polarity reversal refer to section 8.6.

21.4 Function Test (test preparation)

Execute the following function test in the specified order.

- Make sure that the test instrument is connected to mains supply power and that the **mains switch is set to ON**.
Testing for dielectric strength is not possible during battery operation.

Testing the Key Switch and Indicating Devices

An automatic self-test of the signal lamps is performed whenever rotary switch position **HV** has been selected and the voltage test has been launched for the first time, see section 6.

- Set the key switch to the “**symbolic padlock closed**” position.
 - The HV TEST LED lights up if the rotary selector switch is in the HV position.

- Neither the **green** nor the **red** signal lamp may light up.
- The symbols **SIGNAL** (for the signal lamp combination), **OFF** (for the emergency off switch) and **KEY** (for the key switch) are grayed out in the footer of the LCD.

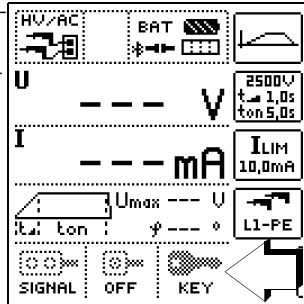

- Set the key switch to the “**symbolic padlock open**” position.
 - The HV TEST LED lights up if the rotary selector switch is in the HV position.

- The **green** signal lamps must light up.
- LCD:
- The symbols **SIGNAL** (for the signal lamp combination), **OFF** (for the emergency off switch) and **KEY** (for the key switch) must appear fully black in the footer of the LCD.

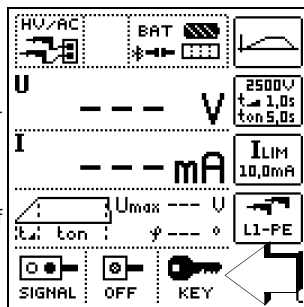

Error

In the event that one of the symbols is grayed out, the signal lamp combination or the emergency off switch is not connected, the emergency off switch is activated or the key switch is not set to the “open” position. A defective signal lamp combination or emergency off switch, or faulty mains power supply, also cause gray-ing out of the respective symbol.

In this case the test instrument is not ready for activation.

If the **ON/START** key is pressed in this case, the following error message appears:

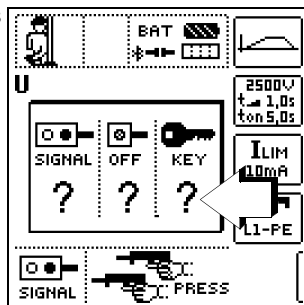

Note

The emergency off switch, the signal lamp combination and mains supply power are continuously monitored during operation.

Activation of the emergency off switch, defective safety devices or faulty mains supply power result in immediate shutdown of the high-voltage module or prevent the test from being started.

Further internal protective measures (e.g. temperature monitoring) continuously ensure the safety of the user as well, and protect the instrument against damage.

Starting the Voltage Test (test run)

Attention!

Only start testing for the absence of voltage in the case of correct indication by means of the connected indicating device for HV operation. Observe the safety precautions in section 3.2 on page 13.

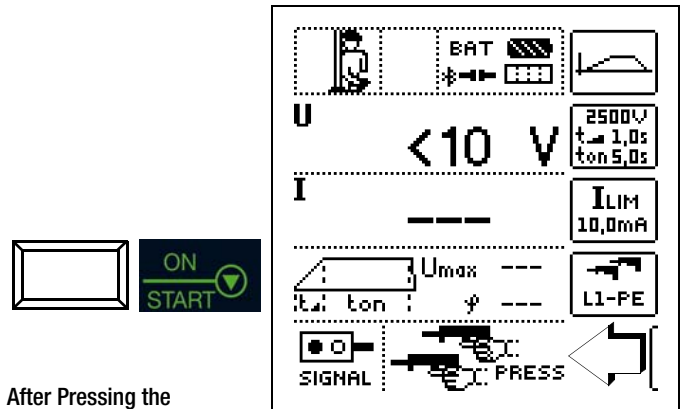

After Pressing the ON/START Key

- The **red** signal lamp must light up, LCD: .
- The high-voltage pistols appear at the display and the **PRESS** message prompts the user to activate them.
- The symbol shown at the right is mirrored from left to right and vice versa until the measurement is started by activating the high-voltage pistols.

Caution: High-Voltage!

Touch **neither** the test probes **nor** the device under test during the test for dielectric strength!
Life endangering high-voltage of up to **2.5 kV** is present at the test probes of the high-voltage pistols!

- Pull the triggers of the high-voltage pistols to the limit stop and hold.

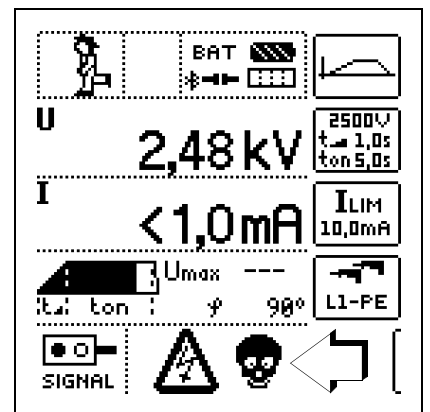

During Voltage Test

- The **RUN** symbol shown at the right is continuously active.
- The **HV TEST** LED blinks.
- The two high-voltage warning symbols appear at the display and alternate back and forth between normal and inverse display.
- A periodic acoustic warning accompanies the measurement.
- Momentary test voltage **U** is displayed.
- The current position within the voltage sequence is indicated by the filled trapezoid.

- Release the triggers at the high-voltage pistols.

No later than after selected test duration t_{on} , test voltage is switched off automatically.

Testing the Shutdown Function

(voltage/standard sequence mode only)

- ⇒ Pull the triggers of the high-voltage pistols to the limit stop and hold.
- ⇒ During measurement: briefly short circuit the high-voltage pistols.
- The instrument is shut down immediately.
- The **green** signal lamp must light up and **red** may not light up.
- The following values appear at the LCD:
 - U : ---
 - I : ---

- ⇒ For subsequent testing of neighboring circuits release the triggers, establish contact with the next circuit and pull the trigger to the limit stop once again. The test is started anew. If breakdown occurs during testing or if the selected shutdown current is not reached, the test must be restarted.

Note

If the next measurement is not started within 30 seconds, the system is switched from ready for activation to the standby mode – the signal lamp combination changes from red to green and measurement must be restarted (safety shutdown).

21.5 Test Sequence



Attention!

Before starting the test, make sure that

- The measurement cables are fully extended
- All access to the danger zone is closed and all persons have exited the danger zone before the testing systems is rendered **ready for activation**

- ⇒ Set the key switch to the “symbolic padlock open” position.

The test instrument is switched to the “standby” mode. The green signal lamp lights up.

- ⇒ Check the test parameters.
- ⇒ Press the ON/START key.

The test instrument is switched from the “standby” mode to “ready for activation”. The red signal lamp lights up, LCD: .

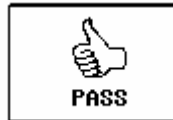
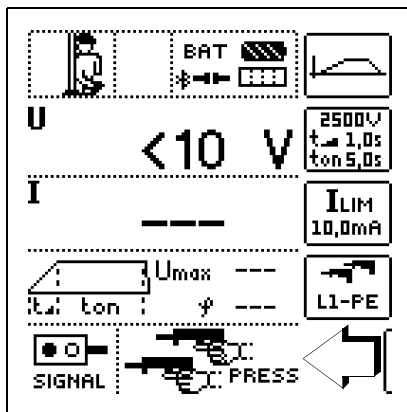

In the case of successful testing (test passed), the device remains in the “ready for activation” state - the red signal lamp remains lit up, LCD: .

The test can be repeated or further testing of dielectric strength can be conducted with the previously selected parameters by once again pulling the triggers of the high-voltage pistols. The pop-up is automatically cleared when the triggers are pulled.

The test is restarted using the same sequence, including the same ramp-up as before. Indication takes place in the same way as well.

The “PASS” pop-up must be cleared by pressing the ESC key in order to view the measured values or save them to the database. The measured values then become visible and the memory key for saving them is enabled.



After saving the measured values, the device is automatically switched back to the “ready for activation” state - the red signal lamp goes out and the green signal lamp lights up once again, LCD: .

In order to conduct further testing or a new test, testing has to be started again by pressing the ON/START key. If applicable, the parameters must first be adjusted.



Caution: High-Voltage!

Touch **neither** the test probes **nor** the device under test during the test for dielectric strength! **Life endangering high-voltage** of up to **2.5 kV** is present at the test probes of the high-voltage pistols!

- ⇒ Position the high-voltage pistols in close proximity to the device under test.
- ⇒ Pull the triggers of both high-voltage pistols, but only up to the point of mechanical resistance at which the test probes are exposed.
- ⇒ Establish contact with the electrical circuits.
- ⇒ Pull the triggers of the high pistols to the limit stop.
 - High-voltage is now switched to the test probes.
 - Testing continues until the selected rise time and the test duration have elapsed, or until the triggers are released in the case of measurement with ramp function.
 - Test time (application of high-voltage from rise to drop-off) is indicated acoustically and optically by the blinking LED at the test instrument.

Test failed:

The test object has not withstood testing for dielectric strength in compliance with the selected parameters for nominal test voltage, test duration and maximum current in the standard sequence operating mode. The limit value has been violated for at least one of the parameters.

If the test has been performed in **continuous operation** mode, the maximum current has been exceeded and/or a breakdown has been detected.

- Maximum current exceeded / breakdown
- Test duration not complied with
- Nominal voltage fallen short of

The tested system segment or test object does not fulfill requirements in accordance with DIN VDE 0113 / EN 60204-1 / IEC 204-1.

The following "FAIL" pop-up appears at the display and a brief, low-pitched acoustic signal is generated:



In the event that testing is failed, the device is automatically switched back to the "ready for activation" state - the red signal lamp goes out and the green signal lamp lights up once again, LCD: 

In order to conduct further testing or a new test, testing has to be started again by pressing the **ON/START** key. If applicable, the parameters must first be adjusted.

Saving Measured Values

After the test sequence has been completed (complete testing with "pass" or "fail" test results), the last acquired measured values for **U_{max}**, **I** and ϕ are retained at the display. The corresponding pop-up with the test results must first of all be cleared to this by pressing the **ESC** key.

If testing has been ended with meaningful test results, the current measured values can be saved to the database with the save key. 

The measured values at the display are overwritten when the next test is executed.

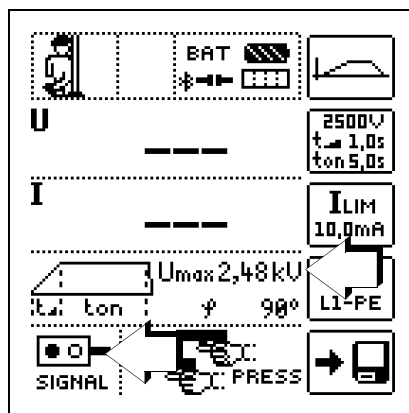

Premature Abortion of the Test

The test can be ended prematurely at any time:

- By pressing the emergency off switch
- By turning the key switch to the "symbolic padlock closed" position
- By Pressing the **ON/START** Key
- By interrupting mains supply power



Note

Breakdown Voltage

If shutdown current **I_{LIM}** is exceeded before the selected test voltage has been reached, test voltage **U** and current **I_{LIM}** measured at this point in time appear at the display and are saved to memory.

Standby Operation

By releasing the trigger of either high-voltage pistol – high voltage is no longer present – the high-voltage testing module switches into the „ready for operation“ mode. A further test is enabled by pressing the two pistols once more. The „ready for operation“ mode is retained for a period of 30 seconds (user-inactivity-time-out). If no pistol is operated during this period, the test is aborted after 30 seconds.

21.5.1 Ending the Test for Dielectric Strength

- Release one or both high-voltage pistols. High voltage is no longer applied. The high-voltage testing module switches into the „ready for operation“ mode, see also chapter "Standby Operation".
- Press the **ON/START** key in order to end the test, if it hasn't already been ended automatically (breakdown or shutdown current reached, green signal lamp already lit up).
- The display at the signal lamp combination changes from red to green, LCD: .
- The test system must be removed from service (signal lamps off) if left unattended. Set the key switch to the "symbolic padlock closed" position to this end.
- Set the key switch to the "symbolic padlock closed" position and remove the key, and secure the device against unauthorized use.

21.5.2 Setting Ranges for Parameters and Standard Values per DIN VDE

Parameter	Lower Limit	Standard Value	Upper Limit	Special Setting
Test duration	0.5 s	1 s	120 s	Continuous measurement
Test voltage	200 V	1 kV or 2 x U _N **	2.5 kV	
Shutdown current I _{MAX}	0.2 mA	—	200 mA	Pulse control mode
Rise time	100 ms	1 s *	99.9 s	

* Recommended

** The respectively larger value must be used.

22 AUTO – Test Sequences (automatic test sequences)

Select the measuring function:



With the rotary switch in the **AUTO** position, all of the test sequences in the device are displayed.

22.1 General

Layout of the Test Sequences

If the same sequence of tests will be run frequently (one after the other with subsequent report generation), for example as specified in the standards, it's advisable to make use of test sequences.

Automated test sequences can be compiled from manually created individual measurements with the help of the test sequence function.

A test sequence consists of up to 200 individual steps, which are executed one after the other.

Fundamentally, differentiation is made amongst three types of individual steps:

- **Note (“visual inspection” test step):** Test sequences are interrupted when a pop-up message is displayed for the inspector. The test sequence is not resumed until the messages has been acknowledged.
Sample message before insulation resistance measurement: “Disconnect the device from the mains!”
- **Visual inspection, testing and report generation:** The test sequence is interrupted when a passed/failed evaluation is displayed. The comment and the results of the evaluation are saved to the database.
- **Measurement (“user-evaluated measurement” test step):** same as individual measurements with the instruments with storage and parameters configuration

Creating Test Sequences with IZYTRONIQ

As of firmware version 1.2.0, test sequences are created at a PC with the help of the included **IZYTRONIQ** software, and are then transferred to test instrument. Any number of test sequences can be created and stored at the PC in **IZYTRONIQ**. Up to 10 selected test sequences can be transferred to the test instrument.

No option for transferring test sequences from the test instrument back to the PC has been provided for because sequences can only be created, managed and stored at a PC.

General instructions regarding the creation of test sequences can be found in the online help provided with **IZYTRONIQ**.

22.2 Creating and Transferring Test Sequences with IZYTRONIQ (step-by-step instructions)

- Select “Stationary Objects” .
- Then select the “Sequences” menu .
- Click the “Add” symbol . The “Create New Sequence” field is displayed. Enter a “Sequence Name”, a “Test Type” and a “Standard”, and select your currently connected instrument under “For Device”. Acknowledge by clicking “Add”.
- Save the settings by clicking the  icon.
- Select the new entry and then the sequence editor . The editing menu appears with “Step Selection” and “Design Progress”.
- Select the test instrument which is displayed in “Step Selection”. “Visual Inspection” and “User-Evaluated Measurement” appear.
- “Test Step: Visual Inspection” is opened in the bottom left-hand window by dragging “Visual Inspection” into the “Design Progress” field. The parameters or details for the respective test step must be entered here.
- Save the settings by clicking the  icon.
- “Test Step: User-Evaluated Measurement” is opened in the bottom left-hand window by dragging “User-Evaluated Measurement” into the “Design Progress” field. The parameters or details for the respective test step must be entered here.
- Save your settings.
- Repeat the test steps until the test sequence is finished.
- Save your settings by clicking the  icon.
- Select “Stationary Objects” again .
- Then select the “Export” function . The export wizard appears.
- Select the desired test instrument and insert a checkmark next to “Sequences”. Select “Export”. The “Export Sequences (max. 10)” menu appears.
- Mark the sequences to be exported and click the “Export to Test Instrument” icon .

For as long as the test sequences are being transferred, a progress bar is displayed at the PC and the illustration shown to the right appears at the test instrument's display.

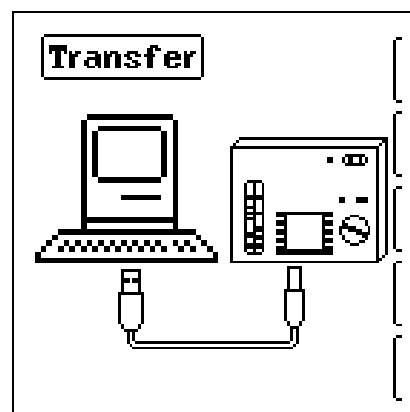

Successful transfer to the test instrument via **IZYTRONIQ** is then indicated at the PC.

Note

All test sequences previously stored at the test instrument are deleted. Only those test sequences transferred during the most recent export operation via **IZYTRONIQ** are saved at the test instrument.

Please note that test sequences which have been loaded to the test instrument are deleted when:

- New test sequences are received from the PC
- The test instrument is reset to its default settings (SETUP switch position → GOME SETTING key)
- The firmware is updated
- The user interface language is changed (SETUP switch position → CULTURE key)
- The test instrument's entire database is deleted

Configuring Test Sequence Parameters

Measurement parameters are also configured at the PC. However, parameters can be changed at the test instrument during the test sequence before the respective measurement is started. When the test step is started once more, the parameter settings specified in **IZYTRONIQ** are loaded again.



Note

IZYTRONIQ does not subject the parameters to a plausibility check. As a result, the newly created test sequence should be checked at the test instrument before it's permanently added to the database.

Limit values are not currently set in **IZYTRONIQ**, and have to be adjusted during the automatic test sequence.

Selecting and Starting a Test Sequence at the Test Instrument

Fig. 22.3

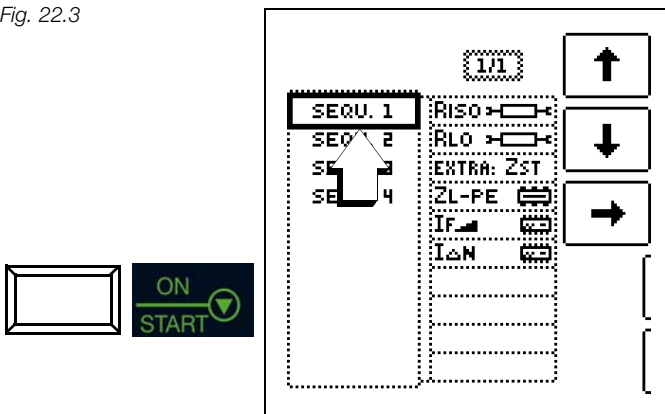

The selected test sequence (SEQU.1 in this case) is started with the **ON/START** key.

When a measurements type test step is executed, the same screen layout appears as is also the case for individual measurements. The current test step number (in this case step 01 of 06) appears in the header instead of the memory and battery symbols (see Fig. 22.4). After pressing the "Save" key twice, the next test step is displayed.

Setting Parameters and Limit Values

Parameters and limit values can also be changed while a test sequence is running or before the respective measurement is started. The respective change only affects the active test sequence and is not saved.

Skipping Test Steps

There are two ways to skip test steps or individual measurements:

- Select the test sequence, change to the test step column at the right with the help of the cursor, select the xth test step and press the **ON/START** key.
- The navigation menu can be opened within the test sequence by pressing the navigation key (cursor left-right). Jumping to the next or the previous test step is possible using the separate scroll keys which then appear.

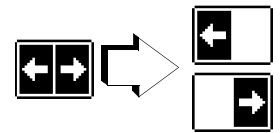

The navigation menu can be exited again and the current test step can be displayed by pressing the **ESC** key.

Aborting or Ending a Test Sequence

An active sequence can be aborted by pressing the **ESC** key and then acknowledging.

"Sequence Ended" appears after the last test step is completed. After acknowledging the prompt, the initial menu, "List of Test Sequences", is once again displayed.

Fig. 22.4

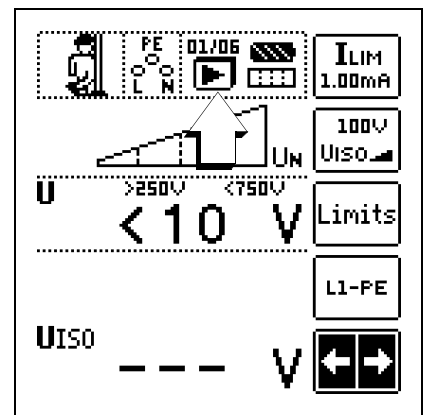

23 Database

23.1 Creating Distributor Structures, General

A complete distributor structure with data for electrical circuits and RCDs can be created in the **PROFITEST PRIME** test instrument. This structure makes it possible to assign measurements to the electrical circuits of various distributors, buildings and customers.

There are two possible procedures:

- On location or at the construction site: create the distributor structure in the test instrument. A distributor structure with up to 30,000 structure elements can be created in the test instrument, which is saved to the instrument's flash memory.

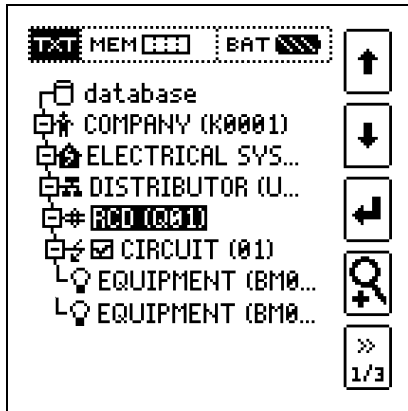

or

- Create and save an existing distributor structure with the help of the **report generating program IZYTRONIQ**.



Notes concerning IZYTRONIQ

Read the online help for the PC program regarding installation and use.

23.2 Transferring Distributor Structures

The following data transfer operations are possible:

- Transfer a distributor structure from the PC to the test instrument.
- Transfer a distributor structure including measured values from the test instrument to the PC.

The test instrument and the PC must be connected with a USB cable in order to transfer structures and data.



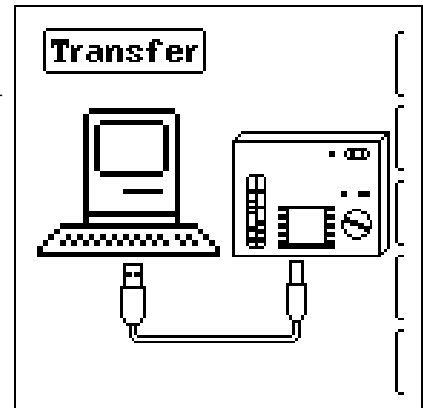















The following image appears at the display during transfer of structures and data.















23.3 Creating a Distributor Structure in the Test Instrument

Overview of the Meanings of Icons used to Create Structures

Symbol	Meaning
Main Level	Sub-Level
	Memory menu, page 1 of 3
↑	Cursor UP: scroll up
↓	Cursor DOWN: scroll down
↵	ENTER: acknowledge selection + → - change to sub-level (open directory) or - → + change to main level (close directory)
+/-	Display the complete structure designation (max. 63 characters) or ID number (25 characters) in a zoom window
TXT ID T&T ID	Temporarily switch back and forth between structure designation and ID number. These keys don't have any effect on the main setting in the setup menu (see "DB Mode" on page 22).
🔍	Hide the zoom window
⌘ 1/3	Change display to menu selection

Symbol	Meaning
	Memory menu, page 2 of 3
	Add a structure element
	Selection: UP/DOWN scroll keys and ↵ In order to add a designation to the selected structure element, refer to the edit menu in following column.
Test instrument	IZY-TRO-NIQ
	Location Tree
	Property
	Building
	Floor
	Room
	E-Tree (electrical tree)
	Customer
	Electrical system
	Machine
	Distributor
	Circuit
	RCD
	RCM
	RCBO
	IMD
	Operating equipment
	Equipotential bonding busbar
	Equipotential bonding conductor
	Earth electrode
	Measuring point

Symbol	Meaning
EDIT	For additional icons see edit menu below
	Delete the selected structure element.
	Show measurement data, if a measurement has been performed for this structure element.
	Edit the selected structure element.
	Memory menu, page 3 of 3
	Search for ID number. > Enter complete ID number.
	Search for text. > Enter full text (complete word).
	Search for ID number or text.
	Continue searching.
	Edit menu
	Cursor LEFT: Select an alphanumeric character.
	Cursor RIGHT: Select an alphanumeric character.
	ENTER: Accept an individual character.
	Acknowledge entry.
←	Scroll left.
→	Scroll right.
	Delete characters.
	Switching amongst different types of alphanumeric characters:
A	✓ ABCDEFGHIJK Upper case letters LMNOPQRSTUVWXYZ XYZL↔
a	✓ abcdefghijk Lower case letters lmnopqrstuvwxyz xyzl↔
0	✓ 0123456789+ Numbers -*/=:;, _ (<> .!?_↔
@	✓ @äÄöÜÜß€\$% Special characters &#äëéëïïöüü ñÑæ↔

Distributor Structure Symbology / Tree Structure

A **check mark** to the right of a structure element means that all measurements within the respective hierarchy have been passed.

x: At least one measurement has not been passed.

No symbol: Measurement has not yet been performed.

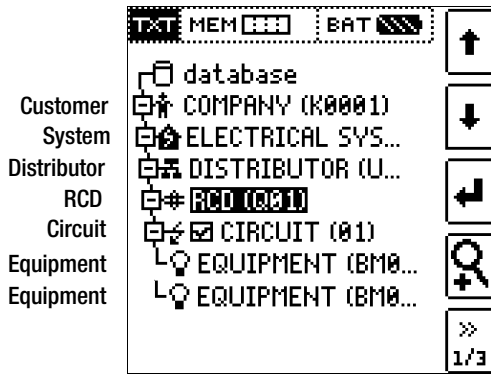

Same type of element as in the Windows Explorer:

+ : sub-objects available, display by pressing ↵.

- : sub-objects are displayed, hide by pressing ↵.

Selecting a New Object from a List

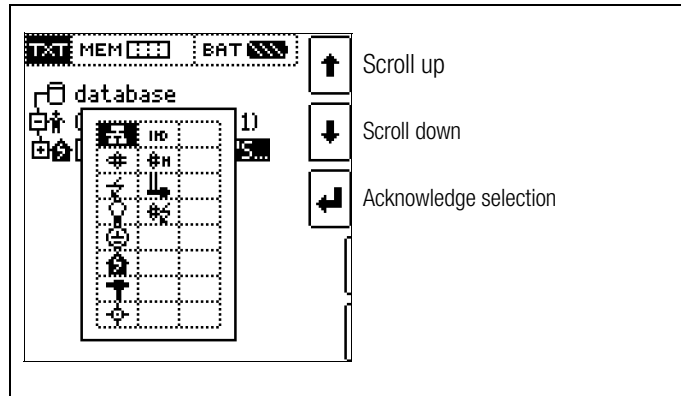

Select the desired object from the list with the ↑↓ keys and acknowledge with the ↵ key.

Entering a Designation

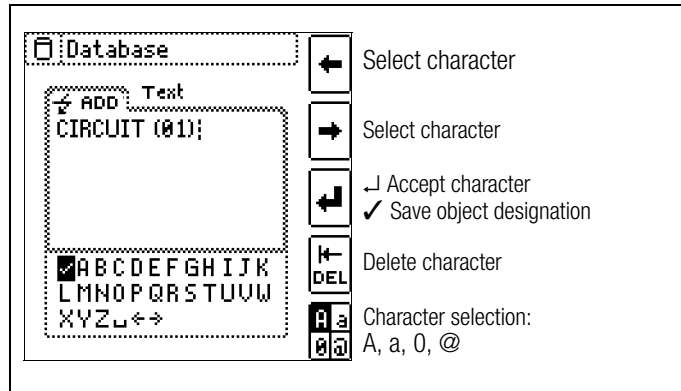

Enter a designation and then acknowledge it by pressing ✓.



Note

Acknowledge the standard or adjusted parameters shown below, because the created designation will otherwise not be accepted and saved.

23.3.1 Creating Structures (example for electrical circuit)

After selection with the **MEM** key, all setting options for the creation of a tree structure are made available on three menu pages (1/3, 2/3 and 3/3). The tree structure consists of structure elements, referred to below as objects.

Selecting the Position at which a New Object will be Added

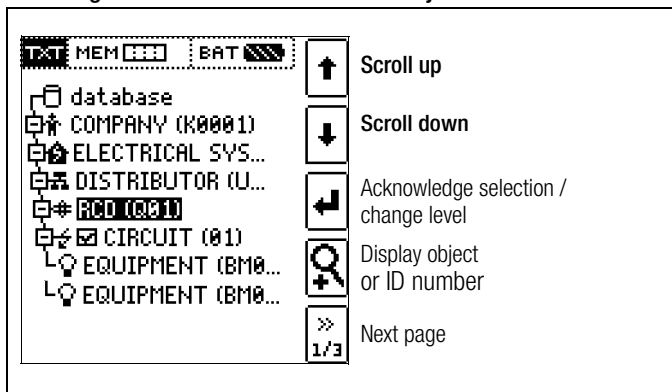

Use the ↑↓ keys in order to select structure elements.

Change to the sub-level with the ↵ key.

Go to the next page with the >> key

Creating a New Object

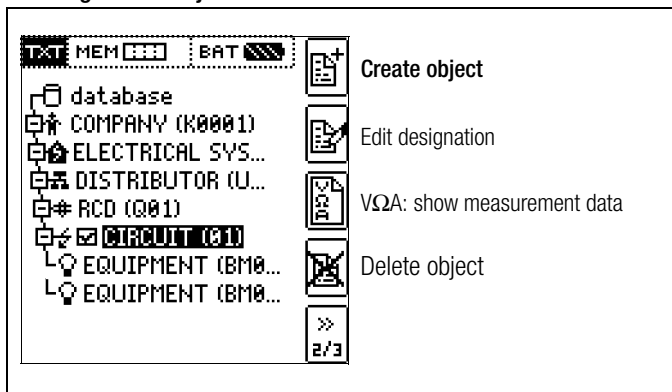

Press the  key in order to create a new object.

Setting Electrical Circuit Parameters

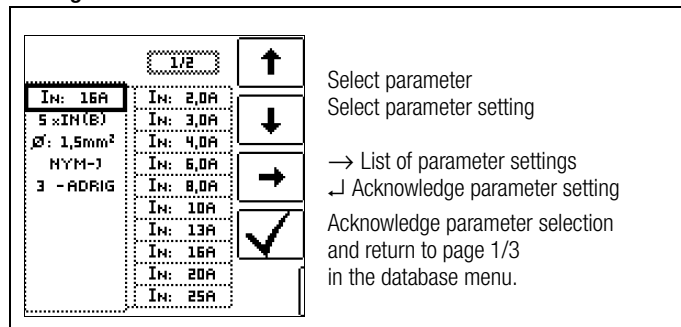

For example, nominal current values must be entered here for the selected electrical circuit. Measuring parameters which have been accepted and saved in this way are subsequently accepted by the current measuring menu automatically when the display is switched from the structure view to measurement.



Note

Electrical circuit parameters changed during structure creation are also retained for individual measurements (measurement without saving data).

If you change the electrical circuit parameters specified by the structure in the test instrument, a warning is displayed when the change is saved.

23.3.2 Searching for Structure Elements

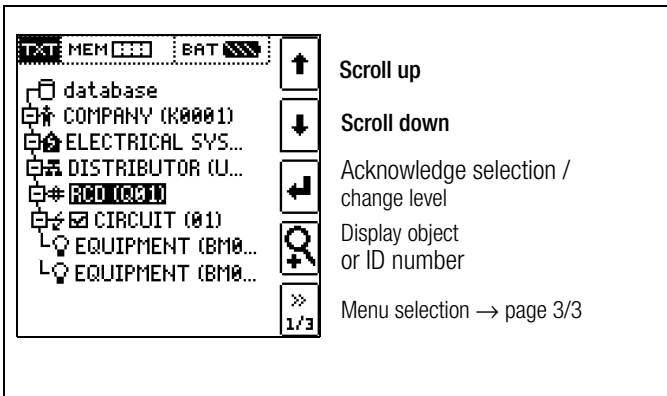

Regardless of the currently selected object, the search is started at **database**.

Go to page 3/3 in the database menu.

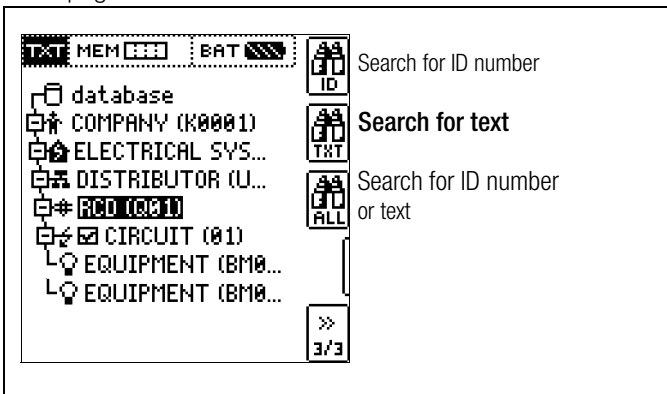

After selecting the text search ...

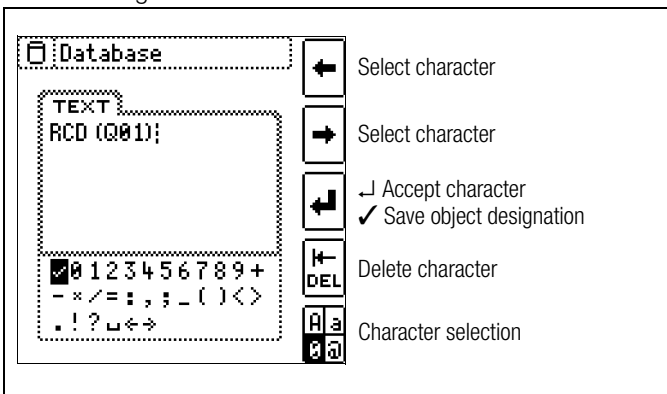

... and entering the desired text (only full matches are found – no wild cards, case sensitive) ...

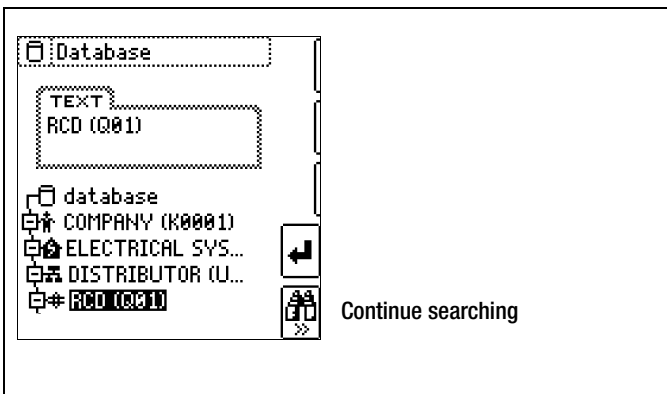

the first match is displayed.

Further matches can be found by selecting the icon shown at the right.

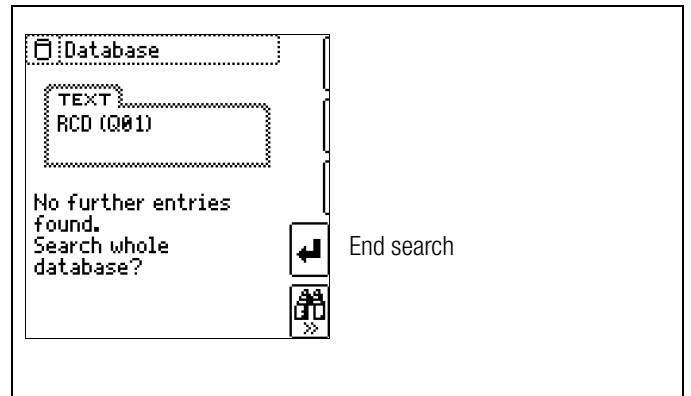

If no further matches are found, the message shown above is displayed.

23.4 Saving Data and Generating Reports

Preparing and Executing a Measurement

Measurements can be performed and stored to memory for each structure element. Proceed as follows, adhering to the prescribed sequence:

- Select the desired measurement with the rotary knob.
 - Start the measurement by pressing the **ON/START** or $I\Delta_N$ key.
- Upon completion of measurement, the "→ floppy disk" softkey is displayed.
- **Briefly** press the "Save Value" key.



The display is switched to the memory menu or the structure view.

- Navigate to the desired memory location, i.e. to the desired structure element / object, for which the measurement data will be saved.
- If you would like to save a comment along with the measurement, press the key shown at the right and enter a designation via the "EDIT" menu as described in section 23.3.1.
- Complete data storage by pressing the "STORE" key.



Storing of Error Messages (Pop-ups)

If a measurement is terminated without a measured value having been produced on account of an error, the associated message can be saved together with the pop-up by pressing the key „Save value“. Instead of the pop-up symbol, the corresponding text is issued to the report generating software. This applies to a limited number of pop-ups only, see below. In the database of the test instrument, neither the symbol nor the text can be retrieved.

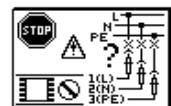
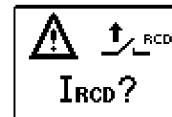
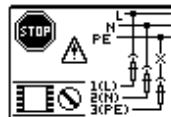

Alternative Storage Procedure

- The measured value can be saved to the last selected object in the structure diagram by **pressing and holding** the "Save Value" key, without switching the display to the memory menu.



Note

If you change the parameters in the measurement view, they are not saved for the structure element. A measurement with changed parameters can nevertheless be saved to the structure element, and any changed parameters are documented in the report for each measurement.

Retrieving Saved Measured Values

- Switch the display to the distributor structure by pressing the **MEM** key and select the desired electrical circuit with the scroll keys.
- Switch to page 2 by pressing the key shown here:
- Display the measurement data by pressing the key shown here:

One measurement with date and time, as well as any comment you might have entered, is displayed in each screen. Example: Insulation Measurement

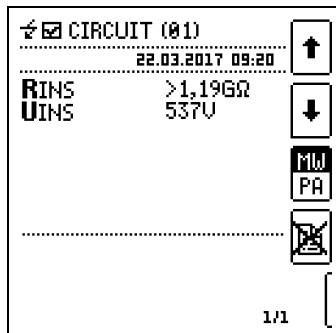

Note

A check mark in the header means that the respective measurement has been passed. An X means that the measurement has not been passed.

- Scrolling amongst measurements is possible with the keys shown here:
- The measurement can be deleted with the key shown here:

A prompt window asks you to confirm deletion.



With the help of the key shown at the right (MW: measured value / PA: parameter), the setting parameters can be displayed for this measurement.

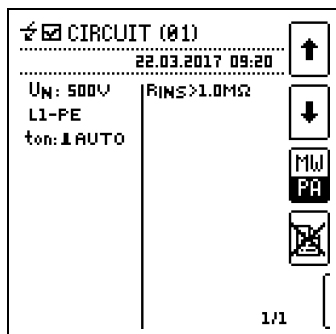

- Scrolling amongst measurements is possible with the keys shown here:

Data Evaluation and Report Generation with the Report Generating Program

All data, including the distributor structure, can be transferred to the PC and evaluated with the help of the report generating program. Additional information can be entered here subsequently for the individual measurements. After pressing the appropriate key, a report including all measurements within a given distributor structure is generated, or the data are exported to an Excel spreadsheet.

Note

The database is exited when the rotary selector switch is turned. Previously selected parameters in the database are not used for the measurement.

23.4.1 Use of Barcode Readers

Search for an Already Scanned Barcode

The search can be started from any switch setting and menu.

- Scan the object's barcode.
- The found barcode is displayed inversely.
- This value is accepted after pressing the ENTER key.

Note

A previously selected object is not taken into consideration by the search.

Continued Searching in General



Regardless of whether or not an object has been found, searching can be continued by pressing the key shown at the right:

- Object found: Searching is continued below the previously selected object.
- No further object found: The entire database is searched at all levels.

Reading In a Barcode for Editing

If the menu for alphanumeric entry is active, any value scanned by means of a barcode reader is accepted directly.













Using a Barcode Printer (accessory)

A barcode printer allows for the following applications:

- Read-out of ID numbers as barcodes – for quick and convenient acquisition for periodic testing
- Print-out of repeatedly occurring designations such as test object types encrypted as barcodes in a list, allowing them to be read in as required for comments.

24 Functionality of the Probes, Indication by Means of LEDs and LCD Symbols

Functionality of the probes

Probe	Rotary Switch Position	Function
Standard	U, RLO 0,2A, RLO 25A, RCD IF  , RCD IΔ _N , RCD IF  +IΔ _N , ZLOOP  , DC+A  , ZLOOP  , ZLOOP  , IMD, RCM, IL, IL/AMP, ΔU, kWh, AUTO	Measure
Active probe „I-SK“	U, RLO 0,2A, RLO 25A, RCD IF  , RCD IΔ _N , RCD IF  +IΔ _N , ZLOOP  , DC+A  , ZLOOP  , ZLOOP  , IMD, RCM, IL, IL/AMP, ΔU, kWh, AUTO ¹⁾	Measure and control
HV pistols	HV ¹⁾	Measure

¹⁾ In rotary switch position „AUTO“ the key functions are deactivated.

The following information is indicated:

Mains connections, charge level, memory occupancy, Bluetooth functions, measuring functions and statuses, potential differences

































Error Acknowledgement































Errors are indicated by means of error popups and must be acknowledged with the following keys:





















At the test instrument: ESC

At the I-SK4/12-PROFITEST-PRIME probe (Z506T/U) :



























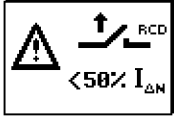







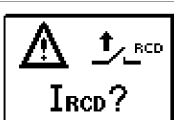

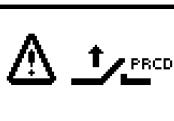

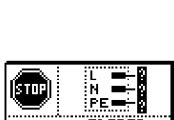







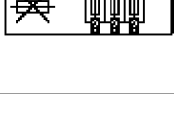





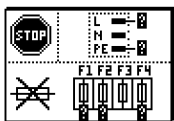





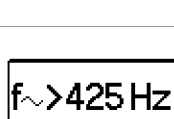













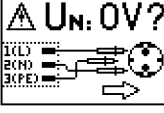







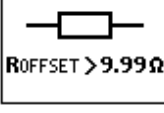

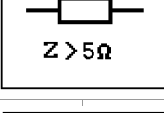











	Status	Rotary Switch Position	Function / Meaning
LED Signals			
MAINS NETZ	Lights up green	RCD IF  , RCD IΔ _N , RCD IF  +IΔ _N , ZLOOP  , DC+A  , ZLOOP  ,  , IMD, RCM, ΔU	Correct connection, line voltage present, measurement enabled
	Blinks green	RCD IF  , RCD IΔ _N , RCD IF  +IΔ _N , ZLOOP  , DC+A  , ZLOOP  ,  , IMD, RCM, ΔU	Probe socket 2(N) not connected, measurement enabled
	Lights up yellow	RCD IF  , RCD IΔ _N , RCD IF  +IΔ _N , ZLOOP  , DC+A  , ZLOOP  ,  , Ures, IMD, RCM, ΔU	Line voltage of 65 to 253 V to PE, two different phases active (no N conductor at mains), measurement enabled
	Blinks yellow	RCD IF  , RCD IΔ _N , RCD IF  +IΔ _N , ZLOOP  , DC+A  , ZLOOP  ,  , IMD, RCM, ΔU	Probe sockets 1(L) and 2(N) are connected to the phase conductors
	Lights up red	RLO 0.2A, RLO 25A, RISO  , RISO  , IL, IL/AMP	Interference voltage detected, measurement disabled
	Blinks red	RCD IF  , RCD IΔ _N , RCD IF  +IΔ _N , ZLOOP  , DC+A  , ZLOOP  ,  , IMD, RCM, ΔU	No line voltage PE interrupted RCD tripped
BATT	Lights up green	All	Battery is fully charged
	Blinks green		– Blinks quickly: quick charging (charge up to 90% only) – Blinks slowly: trickle charge (charge as of 90%)
	Lights up yellow		Battery operation and not fully charged
	Lights up red		– Battery dead – Battery defective

	Status	Rotary Switch Position	Function / Meaning
LED Signals			
UL/RL	Lights up red	RLO 0.2A, RLO 25A, RISO  , RISO  , ZLOOP  , DC+  , ZLOOP  , Ures, IL, IL/AMP, ΔU	- Limit value exceeded or fallen short of
		RCD IF  , RCD IΔ _N , RCD IF  , IΔ _N , ZLOOP  , DC+  , ZLOOP  ,  , RCM	- Limit value for touch voltage U _L exceeded
		IMD, RCM, PRCD, e-mobility	- Evaluation: "NOT OK"
RCD RCCB	Lights up red	RCD IF  , RCD IΔ _N , RCD IF  , IΔ _N	- RCD IF  : the RCD was tripped outside of the specified tripping current limits or was not tripped. - RCD IΔ _N : the RCD was tripped outside of the specified time to trip limits or was not tripped. - RCD IF  + IΔ _N : limit value violation for tripping current or time to trip, or no tripping
Basic measuring functions	Lights up red	U, RLO 0,2A, RLO 25A, RISO  , RISO  , RCD IF  , RCD IΔ _N , RCD IF  , IΔ _N , ZLOOP  , DC+  , ZLOOP  ,  , Ures, IMD, RCM, IL, IL/AMP, Extra, Auto, Setup	Basic measuring functions active
	Off	OFF, T% r.H., HV Charge	Basic measuring functions are not active. Possible causes: - T% r.H. measuring function active - HV measuring function active - "Charge" function active - Instrument defective - No supply power
HV (PROFITEST PRIME AC)	Lights up red	HV	HV measuring function is selected. Basic measuring functions are deactivated.
	Blinks red	HV	HV measuring function is active. High-voltage is present. Basic measuring functions are deactivated.
	Off	OFF, U, RLO 0,2A, RLO 25A, RISO  , RISO  , RCD IF  , RCD IΔ _N , RCD IF  , IΔ _N , ZLOOP  , DC+  , ZLOOP  ,  , Ures, IMD, RCM, IL, IL/AMP, T% r.H., Extra, Auto, Setup Charge	HV measuring function is not active. Possible causes: - Basic measuring functions are active - "Charge" function active - Instrument defective - No supply power





Status	Rotary Switch Position	Function / Meaning
Status Bar: Mains Connection Test – Single-Phase System		
	Is displayed	Connection not yet detected
	Is displayed	Connection OK
	Is displayed	L and N reversed, neutral conductor charged with phase voltage
	Is displayed	No mains connection
	Is displayed	Neutral conductor N interrupted
	Is displayed	Protective conductor PE interrupted, neutral conductor N and/or phase conductor L charged with phase voltage
	Is displayed	Phase conductor L interrupted, neutral conductor N charged with phase voltage
	Is displayed	Phase conductor L and protective conductor PE reversed
	Is displayed	L and N are connected to the phase conductors
Status Bar: Mains Connection Test – 3-Phase System		
	Is displayed	Clockwise rotation
	Is displayed	Counterclockwise rotation
	Is displayed	Conductor-to-conductor short-circuit between phase conductors L1 and L2
	Is displayed	Conductor-to-conductor short-circuit between phase conductors L1 and L3
	Is displayed	Conductor-to-conductor short-circuit between phase conductors L2 and L3
	Is displayed	Phase conductor L1 not detected
	Is displayed	Phase conductor L2 not detected
	Is displayed	Phase conductor L3 not detected
	Is displayed	Probe L1 connected to neutral conductor N
	Is displayed	Probe L2 connected to neutral conductor N
	Is displayed	Probe L3 connected to neutral conductor N





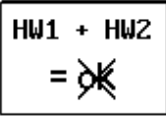
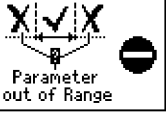
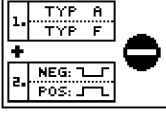

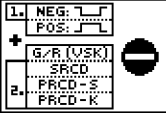
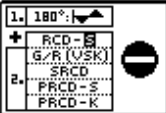

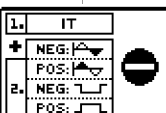
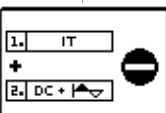
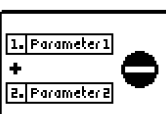

















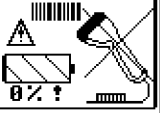



















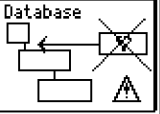



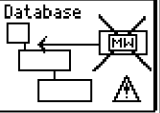

	Status	Rotary Switch Position	Function / Meaning
Status Bar: Display of Charge Level, Memory Occupancy and Bluetooth Function			
Battery status			
	Is displayed	U, RLO 0.2A, RLO 25A,	Battery charge level ≥ 80%
	Is displayed	RISO , RISO ,	Battery charge level ≥ 50%
	Is displayed	RCD IF , RCD IΔN, RCD IF + IΔN,	Battery charge level ≥ 30%
	Is displayed	ZLOOP , DC+ ,	Battery charge level ≥ 15%
	Is displayed	ZLOOP , ,	Battery charge level ≥ 0%
		Ures, IMD, RCM, IL, IL/AMP, ΔU, e-mobility, PRCD, HV-AC, HV-DC, Setup	
Memory status			
	Is displayed		Memory occupancy ≥ 100%
	Is displayed		Memory occupancy ≥ 87.5%
	Is displayed	U, RLO 0.2A, RLO 25A,	Memory occupancy ≥ 75%
	Is displayed	RISO , RISO ,	Memory occupancy ≥ 62.5%
	Is displayed	RCD IF , RCD IΔN, RCD IF + IΔN,	Memory occupancy ≥ 50%
	Is displayed	ZLOOP , DC+ ,	Memory occupancy ≥ 37.5%
	Is displayed	ZLOOP , ,	Memory occupancy ≥ 25%
	Is displayed	Ures, IMD, RCM, IL, IL/AMP, ΔU, e-mobility, PRCD, HV-AC, HV-DC, Setup	Memory occupancy ≥ 12.5%
	Is displayed		Memory occupancy ≥ 0%
Intelligent probe status			
	Is displayed		The symbol is displayed instead of „BAT“, as soon as an intelligent I-SK4/12 probe is connected.
Bluetooth status			
	Is displayed	U, RLO 0.2A, RLO 25A,	Bluetooth connection interrupted, display appears after activation of the Bluetooth function in setup
	Is displayed	RISO , RISO ,	Bluetooth connection established
		RCD IF , RCD IΔN, RCD IF + IΔN, ZLOOP , DC+ ,	
		ZLOOP , ,	
		Ures, IMD, RCM, IL, IL/AMP, ΔU, e-mobility, PRCD, HV-AC, HV-DC, Setup	

Status	Rotary Switch Position	Function / Meaning
Battery Test		
	Is displayed	<p>U, RLO 0,2A, RLO 25A, RISO , RISO , RCD IF , RCD IΔN, RCD IF , IΔN, ZLOOP , DC+ , ZLOOP , , Ures, IMD, RCM, IL, IL/AMP, Extra, HV, Auto, Setup</p>
Error Messages — LCD Connection Pictographs		
	RCD IF  , RCD I Δ N, RCD IF  , I Δ N, ZLOOP  , DC+  , ZLOOP  , 	<p>Voltage to probes 1(L), 2(N), 3(PE) not within the permissible range. Measurement is not possible.</p> <p>⇨ Check the mains connection.</p>
	RLO 0.2A, RCD I Δ N	<p>RCD has been tripped too early or is defective.</p> <p>⇨ Check the system for bias current.</p>
	ZLOOP  , ZLOOP  , 	<p>RCD has been tripped too early or is defective.</p> <p>⇨ Use the ZLOOP DC+ measuring function </p> <p>or</p> <p>⇨ Check the selected nominal test current at the RCD (ZLOOP , )</p>
	RCD IF  , RCD I Δ N, RCD IF  , I Δ N	<p>RCD tripped during touch voltage measurement.</p> <p>⇨ Check the selected nominal test current at the RCD.</p>
	RLO 0.2A RCD IF  , RCD I Δ N, RCD IF  , I Δ N	<p>The PRCD has been tripped.</p> <p>⇨ Poor contact or defective PRCD</p>
	RLO 0,2A, RLO 25A, RISO  , RISO  , RCD IF  , RCD I Δ N, RCD IF  , I Δ N, ZLOOP  , DC+  , ZLOOP  ,  , IMD, RCM, Extra, Auto	<p>The measuring path is faulty.</p> <p>⇨ Check measurement cables 1(L), 2(N) and 3(PE) for correct connection.</p> <p>⇨ Check fuses F1, F2 and F3. Replace defective fuses.</p> <p>Observe notes regarding fuse replacement in section 26.4!</p> <p>The voltage ranges remain functional even if fuses have blown.</p>
	RLO 0,2A, RLO 25A, RISO  , RISO  , RCD IF  , RCD I Δ N, RCD IF  , I Δ N, ZLOOP  , RCM, IL Extra, Auto	<p>The measuring path is faulty.</p> <p>⇨ Check measurement cables 1(L) and 3(PE) for correct connection.</p> <p>⇨ Check fuses F1, F2 and F4. Replace defective fuses.</p> <p>Observe notes regarding fuse replacement in section 26.4!</p> <p>The voltage ranges remain functional even if fuses have blown.</p>
	RCD IF  , RCD I Δ N, RCD IF  , I Δ N, ZLOOP  , DC+  , ZLOOP  ,  , IMD, RCM, Extra, Auto	<p>Line frequency at the device under test not within the permissible range</p> <p>⇨ Check mains connection and contacting</p>
	RCD IF  , RCD I Δ N, RCD IF  , I Δ N, ZLOOP  , DC+  , ZLOOP  ,  , IMD, RCM, Extra, Auto, HV	<p>Excessive temperature inside the test instrument</p> <p>⇨ Wait for test instrument to cool down.</p>











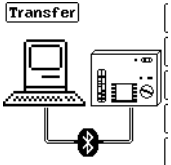
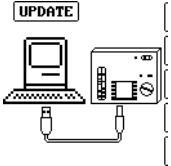







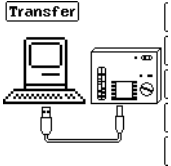



Status	Rotary Switch Position	Function / Meaning
	RLO 0,2A, RLO 25A, RISO  , RISO  , IL, IL/AMP	Interference voltage at probes 1(L), 2(N) and 3(PE) ⇨ Ensure absence of voltage at the device under test.
	RISO  , RISO 	Overvoltage or overload at the internal test voltage generator ⇨ Ensure absence of voltage at the device under test.
	RCD IF  , RCD IΔ _N , RCD IF  , IΔ _N , ZLOOP  , DC+  , ZLOOP  ,  , IMD, RCM	No mains connection detected ⇨ Check connection and contacting of probes 1(L), 2(N) and 3(PE) at the device under test.
	RLO 0.2A	Waiting time for changing the test current flow direction
	RLO 0.2A	When measuring with changing polarity, the results of the individual RLO+ and RLO- measurements deviate from each other by more than 10%: OFFSET measurement is not sensible. ⇨ Check contacting and system. OFFSET measurement of RLO+ and RLO- is still possible.
	RLO 0,2A	R _{OFFSET} > 9.99 Ω: OFFSET measurement is not sensible. ⇨ Check contacting and system.
	RLO 25A	R _{OFFSET} > 1 Ω: OFFSET measurement is not sensible. ⇨ Check contacting and system.
	EXTRA → ΔU	Z _{OFFSET} > 5 Ω: OFFSET measurement is not sensible. ⇨ Check contacting and system.
	EXTRA → ΔU	ΔU _{OFFSET} > ΔU: OFFSET value is greater than the measured value at the consuming system. OFFSET measurement is not sensible. ⇨ Check contacting and system.
	RCD IF  , RCD IΔ _N , ZLOOP DC+  , ZLOOP 	⇨ Reverse contacting of test probes 1(L) and 2(N).
	RCD IF  , RCD IΔ _N , RCD IF  , IΔ _N , ZLOOP  , DC+  , ZLOOP  , 	⇨ Reverse contacting of test probes 1(L) and 3(PE).
	RCD IF  , RCD IΔ _N , RCD IF  , IΔ _N , ZLOOP  , DC+  , ZLOOP  ,  , IMD, RCM	Mains connection errors ⇨ Check the mains connection!
	RCD IF  , RCD IΔ _N , RCD IF  , IΔ _N	Protective conductor interrupted

Status	Rotary Switch Position	Function / Meaning
	I _L /AMP	Note: After changing the current clamp transformation ratio at the test instrument, it must also be adjusted at the current clamp.
	I _L /AMP	Note: After changing the current clamp transformation ratio at the test instrument, it must also be adjusted at the current clamp.
	I _L /AMP	Note: After changing the current clamp transformation ratio at the test instrument, it must also be adjusted at the current clamp.
	I _L /AMP	Note: After changing the current clamp transformation ratio at the test instrument, it must also be adjusted at the current clamp.
	I _L /AMP	Note: After changing the current clamp transformation ratio at the test instrument, it must also be adjusted at the current clamp.
	I _L /AMP	Note: After changing the current clamp transformation ratio at the test instrument, it must also be adjusted at the current clamp.
	RCD IF Δ , RCD I Δ _N , ZLOOP DC+AC	Resistance in the N-PE path is too high. ☞ Check the test setup!
	ZLOOP AC, DC+AC, ZLOOP AC	Touch voltage limit value U _L has been exceeded. ☞ Repeat the measurement in the ZLOOP rotary switch position
	RLO 25A	Line voltage for auxiliary power is not within the permissible range. ☞ Measurement cannot be conducted – check the mains connection! ☞ Turn the mains plug and restart.
	RLO 25A, HV	No line voltage for auxiliary power, or line voltage is too low. ☞ Measurement cannot be conducted – check the mains connection!
	RLO 25A, HV	Line frequency for auxiliary power is not within the permissible range. ☞ Measurement cannot be conducted – check the mains connection!
	RLO 25A	Maximum test current has been exceeded. ☞ Use approved test probes Z506T, Z506U ...
	HV	Measurement not enabled ☞ Check the following: – Connection of the signal lamp combination and the emergency off switch – Key switch position
	HV	HV measuring functions are not available. HV measuring functions are only available for the PROFITEST PRIME AC and PROFITEST PRIME DC variants.

Status	Rotary Switch Position	Function / Meaning
	RCD IF Δ , RCD Δ_N , RCD IF $\Delta+I_{\Delta N}$, ZLOOP Δ , DC+ Δ , ZLOOP Δ , Δ , Δ , IMD, RCM	Internal hardware versions do not correspond. Remedy: 1) Switch off and back on or 2) Fully charge the battery ⇨ If this error message is still displayed send the test instrument to GMC-I Service GmbH.
Entry Plausibility Check – Parameters Combination Checking — LCD Pictographs		
		Measurement is not possible with the selected setting.
	RCD IF Δ , RCD Δ_N , RCD IF $\Delta+I_{\Delta N}$	Measurement is not possible with the selected setting. DC not possible with types A and F.
	RCD IF Δ , RCD Δ_N , RCD IF $\Delta+I_{\Delta N}$	Measurement is not possible with the selected setting.
	RCD IF Δ , RCD Δ_N , RCD IF $\Delta+I_{\Delta N}$	Measurement is not possible with the selected setting. Types B, B+ and EV not possible with G/R, SRCD or PRCD.
	RCD IF Δ , RCD Δ_N , RCD IF $\Delta+I_{\Delta N}$	Measurement is not possible with the selected setting. DC not possible with G/R, SRCD or PRCD.
	RCD IF Δ , RCD Δ_N , RCD IF $\Delta+I_{\Delta N}$	Measurement is not possible with the selected setting. ½ test current not possible with DC.
	RCD IF Δ , RCD Δ_N , RCD IF $\Delta+I_{\Delta N}$	Measurement is not possible with the selected setting. 180° not possible for RCD-S, G/R, SRCD, PRCD.
	RCD IF Δ , RCD Δ_N , RCD IF $\Delta+I_{\Delta N}$	Measurement is not possible with the selected setting. The intelligent ramp is not possible with RCD types RCD-S and G/R.
	RCD IF Δ , RCD Δ_N , RCD IF $\Delta+I_{\Delta N}$	Measurement is not possible with the selected setting. Measurement with half-wave or DC is not possible in IT systems.
	RCD IF Δ , RCD Δ_N , RCD IF $\Delta+I_{\Delta N}$	Measurement is not possible with the selected setting. Measurement with half-wave or DC is not possible in IT systems.
	RCD IF Δ , RCD Δ_N , RCD IF $\Delta+I_{\Delta N}$	The parameters you have selected do not make sense in combination with previously configured parameters. The selected parameter settings will not be saved. Remedy: Enter other parameter settings.

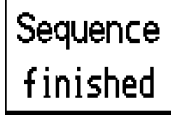
Status	Rotary Switch Position	Function / Meaning
Database and Entry Operations — LCD Pictographs		
 The measuring parameters differ from the object data Do you wish to adapt the database?	RCD IF  , RCD I Δ _N , RCD IF  +I Δ _N , ZLOOP  , DC+  , ZLOOP  ,  , IMD, RCM	The parameters saved to the database for the object differ from the selected electrical circuit parameters. <input checked="" type="checkbox"/> : The measured values will be saved and the parameters in the database will be adjusted. <input type="checkbox"/> : The measured values will be saved. Database parameters remain unchanged.
 TXT = ? Abc...123 !	U, RLO 0,2A, RLO 25A, RISO  , RISO  , RCD IF  , RCD I Δ _N , RCD IF  +I Δ _N , ZLOOP  , DC+  , ZLOOP  ,  , Ures, IMD, RCM, IL, IL/AMP, Extra, HV, Auto, Setup	Please enter an alphanumeric designation.
  0% ?	U, RLO 0,2A, RLO 25A, RISO  , RISO  , RCD IF  , RCD I Δ _N , RCD IF  +I Δ _N , ZLOOP  , DC+  , ZLOOP  ,  , Ures, IMD, RCM, IL, IL/AMP, Extra, HV, Auto, Setup	Barcode scanner inoperable due to excessively low battery voltage.
 CODE ?	U, RLO 0,2A, RLO 25A, RISO  , RISO  , RCD IF  , RCD I Δ _N , RCD IF  +I Δ _N , ZLOOP  , DC+  , ZLOOP  ,  , Ures, IMD, RCM, IL, IL/AMP, Extra, HV, Auto, Setup	Barcode not recognized, incorrect syntax.
  I(RS232) >IMAX		Current via the RS 232 port is too high. The barcode scanner is not suitable.
	U, RLO 0,2A, RLO 25A, RISO  , RISO  , RCD IF  , RCD I Δ _N , RCD IF  +I Δ _N , ZLOOP  , DC+  , ZLOOP  ,  , Ures, IMD, RCM, IL, IL/AMP, Extra, HV, Auto, Setup	No data can be entered here.
	U, RLO 0,2A, RLO 25A, RISO  , RISO  , RCD IF  , RCD I Δ _N , RCD IF  +I Δ _N , ZLOOP  , DC+  , ZLOOP  ,  , Ures, IMD, RCM, IL, IL/AMP, Extra, HV, Auto, Setup	No measured values can be saved here.

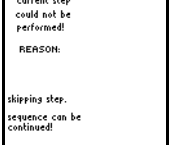

Status	Rotary Switch Position	Function / Meaning
	U, RLO 0,2A, RLO 25A, RISO , RISO , RCD IF , RCD IΔ _N , RCD IF +IΔ _N , ZLOOP , DC+ , ZLOOP , , Ures, IMD, RCM, IL, IL/AMP, Extra, HV, Auto, Setup	Memory is full. Save data to a PC and then clear the database directly at test instrument, or by importing an empty database.
	U, RLO 0,2A, RLO 25A, RISO , RISO , RCD IF , RCD IΔ _N , RCD IF +IΔ _N , ZLOOP , DC+ , ZLOOP , , Ures, IMD, RCM, IL, IL/AMP, Extra, HV, Auto, Setup	Delete the measurement / test step. YES: deletion is executed. NO: deletion is aborted.
	Setup	Delete the database? appears after changing the language or selecting "GOME Settings": restore default settings. YES: deletion is executed. NO: deletion is aborted.
		The created structure is too large for device memory. Data transmission is aborted.
	U, RLO 0,2A, RLO 25A, RISO , RISO , RCD IF , RCD IΔ _N , RCD IF +IΔ _N , ZLOOP , DC+ , ZLOOP , , Ures, IMD, RCM, IL, IL/AMP, Extra, HV, Auto, Setup	The desired object could not be found.
	U, RLO 0,2A, RLO 25A, RISO , RISO , RCD IF , RCD IΔ _N , RCD IF +IΔ _N , ZLOOP , DC+ , ZLOOP , , Ures, IMD, RCM, IL, IL/AMP, Extra, HV, Auto, Setup	The desired object could not be found.
	Setup	Bluetooth connection could not be established.
	Setup	Bluetooth connection established
	Setup	Enter the test instrument's PIN at the other device in order to establish a Bluetooth connection.

Status	Rotary Switch Position	Function / Meaning
	Setup	Data transmission via Bluetooth is active.
	U, RLO 0,2A, RLO 25A, RISO  , RISO  , RCD IF  , RCD IΔ _N , RCD IF  , IΔ _N , ZLOOP  , DC+  , ZLOOP  ,  , Ures, IMD, RCM, IL, IL/AMP, Extra, HV, Auto, Setup	Update will be executed via the USB port.
	U, RLO 0,2A, RLO 25A, RISO  , RISO  , RCD IF  , RCD IΔ _N , RCD IF  , IΔ _N , ZLOOP  , DC+  , ZLOOP  ,  , Ures, IMD, RCM, IL, IL/AMP, Extra, HV, Auto, Setup	Data transmission via USB is active.
	Auto	The test sequence includes a measurement which cannot be processed. The test step will be skipped.
	Auto	The test sequence has been run successfully.
	Auto	No test sequences have been saved.
	Auto	The current sequence step could not be executed. The step will be skipped. The sequence can be resumed.
	Auto	No test sequences have been saved.

25 Characteristic Values

Function	Measured Quantity	Display Range	Resolution	Input Impedance / Test Current	Measuring Range	Nominal Values	Measuring Uncertainty	Intrinsic Uncertainty	Connections					
									1(L)	2(N)	3(PE)	Current Clamp	Other	
U	U	0.0 ... 99.9 V 100 ... 999 V	0.1 V 1 V	5 M Ω	2.0 ... 99.9 V _{RMS} 100 ... 999 V _{RMS}		$\pm(2\% \text{ rdg.} + 5 \text{ d})$ $\pm(2\% \text{ rdg.} + 1 \text{ d})$	$\pm(1\% \text{ rdg.} + 5 \text{ d})$ $\pm(1\% \text{ rdg.} + 1 \text{ d})$	●		●			
	U ₃₋	0.0 ... 99.9 V 100 ... 999 V	0.1 V 1 V		2.0 ... 99.9 V _{RMS} 100 ... 999 V _{RMS}		$\pm(3\% \text{ rdg.} + 5 \text{ d})$ $\pm(3\% \text{ rdg.} + 1 \text{ d})$	$\pm(2\% \text{ rdg.} + 5 \text{ d})$ $\pm(2\% \text{ rdg.} + 1 \text{ d})$	●	●	●			
	f	DC; 15.0 ... 99.9 Hz 100 ... 999 Hz	0.1 Hz 1 Hz		DC, 15.4 ... 420 Hz		$\pm(0.2\% \text{ rdg.} + 1 \text{ d})$	$\pm(0.1\% \text{ rdg.} + 1 \text{ d})$	●		●			
RLO 0.2 A	RLO	0.00 ... 9.99 Ω 10.0 ... 99.9 Ω 100 ... 199 Ω	0.01 Ω 0.1 Ω 1 Ω	$I \geq 200 \text{ mA DC}$ $I < 260 \text{ mA DC}$	0.10 ... 5.99 Ω 6.00 ... 99.9 Ω	$U_q = 4.5 \text{ V}$	$\pm(4\% \text{ rdg.} + 2 \text{ d})$	$\pm(2\% \text{ rdg.} + 2 \text{ d})$	●		●		PRCD adapter	
	ROFFSET	0.00 ... 9.99 Ω	0.01 Ω	$I \geq 200 \text{ mA DC}$ $I < 260 \text{ mA DC}$	0.10 ... 5.99 Ω 6.00 ... 9.99 Ω									
RLO 25 A	RLO	1 m ... 999 m Ω 1.00 ... 9.99 Ω 10.0 ... 20.0 Ω	1 m Ω 0.01 Ω 0.1 Ω	$I \geq 25 \text{ A AC}^1$ $I < 25 \text{ A AC}^1$	10 m Ω ... 50 m Ω 51 m Ω ... 20.0 Ω	$U_q < 8.8 \text{ V AC}$	$\pm(4\% \text{ rdg.} + 2 \text{ d})$	$\pm(2\% \text{ rdg.} + 2 \text{ d})$	●		●			
	ROFFSET	1 m ... 999 m Ω	1 m Ω	$I \geq 25 \text{ A AC}^1$	10 m Ω ... 50 m Ω 51 m Ω ... 999 m Ω									
RISO	RISO	1 ... 999 k Ω 1.00 ... 9.99 M Ω 10.0 ... 49.9 M Ω	1 k Ω 0.01 M Ω 0.1 M Ω	$I_k < 1.6 \text{ mA}$ (for $U_{INS} = 15 \text{ V} \dots 1.00 \text{ kV}$)	50 ... 999 k Ω 1.00 ... 49.9 M Ω	$U_N = 50 \text{ V}$ $I_N = 1 \text{ mA}$	$\pm(5\% \text{ rdg.} + 10 \text{ d})$ $\pm(5\% \text{ rdg.} + 2 \text{ d})$	$\pm(3\% \text{ rdg.} + 10 \text{ d})$ $\pm(3\% \text{ rdg.} + 1 \text{ d})$	●		●			
		1 ... 999 k Ω 1.00 ... 9.99 M Ω 10.0 ... 99.9 M Ω	1 k Ω 0.01 M Ω 0.1 M Ω		50 ... 999 k Ω 1.00 ... 99.9 M Ω	$U_N = 100 \text{ V}$ $I_N = 1 \text{ mA}$	$\pm(5\% \text{ rdg.} + 10 \text{ d})$ $\pm(5\% \text{ rdg.} + 2 \text{ d})$	$\pm(3\% \text{ rdg.} + 10 \text{ d})$ $\pm(3\% \text{ rdg.} + 1 \text{ d})$						
		1 ... 999 k Ω 1.00 ... 9.99 M Ω 10.0 ... 99.9 M Ω 100 ... 200 M Ω	1 k Ω 0.01 M Ω 0.1 M Ω 1 M Ω		50 ... 999 k Ω 1.00 ... 200 M Ω	$U_N = 250 \text{ V}$ $I_N = 1 \text{ mA}$	$\pm(5\% \text{ rdg.} + 10 \text{ d})$ $\pm(5\% \text{ rdg.} + 2 \text{ d})$	$\pm(3\% \text{ rdg.} + 10 \text{ d})$ $\pm(3\% \text{ rdg.} + 1 \text{ d})$						
		1 ... 999 k Ω 1.00 ... 9.99 M Ω 10.0 ... 99.9 M Ω 100 ... 999 M Ω 1.00 ... 1.20 G Ω	1 k Ω 0.01 M Ω 0.1 M Ω 1 M Ω 0.01 G Ω		50 ... 999 k Ω 1.00 ... 499 M Ω 500 M Ω ... 1.20 G Ω	$U_N = 325 \text{ V}$ $U_N = 500 \text{ V}$ $U_N = 1000 \text{ V}$ $I_N = 1 \text{ mA}$	$\pm(5\% \text{ rdg.} + 10 \text{ d})$ $\pm(5\% \text{ rdg.} + 2 \text{ d})$ $\pm(10\% \text{ rdg.} + 2 \text{ d})$	$\pm(3\% \text{ rdg.} + 10 \text{ d})$ $\pm(3\% \text{ rdg.} + 1 \text{ d})$ $\pm(6\% \text{ rdg.} + 1 \text{ d})$						
	U U _{INS}	10 ... 999 V– 1.00 ... 1.19 kV	1 V 0.01 kV		25 V ... 1.19 kV	$U_N = 50, 100, 250, 325, 500, 1000 \text{ V DC}$	$\pm(3\% \text{ rdg.} + 1 \text{ d})$	$\pm(1.5\% \text{ rdg.} + 1 \text{ d})$						
RISO	U U _{INS}	10 ... 999 V– 1.00 ... 1.19 kV	1 V 0.01 kV	$I_k < 1.6 \text{ mA}$	25 V ... 1.19 kV	$U_N = 50, 100, 250, 325, 500, 1000 \text{ V}$	$\pm(3\% \text{ rdg.} + 1 \text{ d})$	$\pm(1.5\% \text{ rdg.} + 1 \text{ d})$	●		●			
RCD If	U ΔN	0.0 ... 70.0 V	0.1 V	$0.33 \cdot I_{\Delta N}$ $I_{\Delta N} = 10 \text{ mA} \dots 1000 \text{ mA}$	5.0 ... 70.0 V		$\pm(1\% \text{ rdg.} + 1 \text{ d})$... $\pm(10\% \text{ rdg.} + 1 \text{ d})$	$\pm(1\% \text{ rdg.} + 1 \text{ d})$... $\pm(9\% \text{ rdg.} + 1 \text{ d})$	●	● ²	●		PRCD adapter	
	RE	10 ... 999 Ω 1.00 ... 6.51 k Ω	1 Ω 0.01 k Ω	$I_{\Delta N} = 10 \text{ mA} \cdot 1.05$	Calculated value Off $R_E = U_{\Delta N} / I_{\Delta N}$	$U_{\Delta N} = 25, 50, 65 \text{ V}$								
		3 ... 999 Ω 1.00 ... 2.17 k Ω	1 Ω 0.01 k Ω	$I_{\Delta N} = 30 \text{ mA} \cdot 1.05$										
		1 ... 651 Ω	1 Ω	$I_{\Delta N} = 100 \text{ mA} \cdot 1.05$										
		0.3 ... 99.9 Ω 100 ... 217 Ω	0.1 Ω 1 Ω	$I_{\Delta N} = 300 \text{ mA} \cdot 1.05$										
		0.2 ... 9.9 Ω 10 ... 130 Ω	0.1 Ω 1 Ω	$I_{\Delta N} = 500 \text{ mA} \cdot 1.05$										
0.2 ... 9.9 Ω 10 ... 65 Ω	0.1 Ω 1 Ω	$I_{\Delta N} = 1000 \text{ mA} \cdot 1.05$												
I Δ	3.0 ... 99.9 mA 100 ... 999 mA 1.00 ... 2.50 A	0.1 mA 1 mA 0.01 A	$(0.3 \dots 1.3) \times I_{\Delta N}$ $(0.3 \dots 1.4) \times I_{\Delta N}$ $(0.2 \dots 2.5) \times I_{\Delta N}$ $I_{\Delta N} = 10 \text{ mA} \dots 1000 \text{ mA}$	3.0 mA ... 2.50 A	$U_N = 120, 230, 400 \text{ V}$ $f_N = 16.7, 50, 60, 200, 400 \text{ Hz}$	$\pm(5\% \text{ rdg.} + 3 \text{ d})$	$\pm(3.5\% \text{ rdg.} + 2 \text{ d})$							
U	0.0 ... 99.9 V 100 ... 999 V	0.1 V 1 V	5 M Ω	2.0 ... 99.9 V 100 ... 440 V	$I_{\Delta N} = 10, 30, 100, 300, 500, 1000 \text{ mA}$	$\pm(2\% \text{ rdg.} + 5 \text{ d})$ $\pm(2\% \text{ rdg.} + 1 \text{ d})$	$\pm(1\% \text{ rdg.} + 5 \text{ d})$ $\pm(1\% \text{ rdg.} + 1 \text{ d})$							
f	15.0 ... 99.9 Hz 100 ... 999 Hz	0.1 Hz 1 Hz		15.4 ... 420 Hz		$\pm(0.2\% \text{ rdg.} + 1 \text{ d})$	$\pm(0.1\% \text{ rdg.} + 1 \text{ d})$							

Function	Measured Quantity	Display Range	Resolution	Input Impedance / Test Current	Measuring Range	Nominal Values	Measuring Uncertainty	Intrinsic Uncertainty	Connections					
									1(L)	2(N)	3(PE)	Current Clamp	Other	
RCD I _{ΔN}	U _{IΔN}	0.0 ... 70.0 V	0.1 V	0.33 · I _{ΔN} I _{ΔN} = 10 mA ... 1000 mA	5.0 ... 70.0 V	U _{IΔN} = 25, 50, 65 V	+1% rdg. + 1 d ... +10% rdg. + 1 d	+(1% rdg. + 1 d) ... +(9% rdg. + 1 d)	●	● ²	●		PRCD adapter	
	R _E	10 ... 999 Ω 1.00 ... 6.51 kΩ	1 Ω 0.01 kΩ	I _{ΔN} = 10 mA · 1.05	Calculated value Off R _E = U _{IΔN} / I _{ΔN}		U _{IΔN} = 25, 50, 65 V							
		3 ... 999 Ω 1.00 ... 2.17 kΩ	1 Ω 0.01 kΩ	I _{ΔN} = 30 mA · 1.05										
		1 ... 651 Ω	1 Ω	I _{ΔN} = 100 mA · 1.05										
		0.3 ... 99.9 Ω 100 ... 217 Ω	0.1 Ω 1 Ω	I _{ΔN} = 300 mA · 1.05										
		0.2 ... 9.9 Ω 10 ... 130 Ω	0.1 Ω 1 Ω	I _{ΔN} = 500 mA · 1.05										
		0.2 ... 9.9 Ω 10 ... 65 Ω	0.1 Ω 1 Ω	I _{ΔN} = 1000 mA · 1.05										
	I _T			0.5x: 0.95 · 0.5 · I _{ΔN} 1x: 1.05 · I _{ΔN} 1.4x: 1.47 · I _{ΔN} 2x: 2.1 · I _{ΔN} 5x: 5.25 · I _{ΔN}			U _N = 120, 230, 400 V f _N = 16.7 ³ , 50, 60, 200, 400 Hz	(0.5·I _{ΔN}) -10% ... +0%						(0.95·0.5·I _{ΔN}) ±3.5%
t _a	0 ... 999 ms	1 ms	5 0.5x, 1x, 2x, 5x 5 0.5x, 1x 5 1x	0 ... 999 ms		±4 ms	±3 ms							
U	0.0 ... 99.9 V 100 ... 999 V	0.1 V 1 V		2.0 ... 99.9 V 100 ... 440 V	I _{ΔN} = 10, 30, 100, 300, 500, 1000 mA	±(2% rdg.+5 d) ±(2% rdg. + 1 d)	±(1% rdg.+5 d) ±(1% rdg. + 1 d)							
f	15.0 ... 99.9 Hz 100 ... 999 Hz	0.1 Hz 1 Hz	I _{ΔN} = 10 mA ... 1000 mA	15.4 ... 420 Hz		±(0.2% rdg. + 1 d)	±(0.1% rdg. + 1 d)							
RCD IF + I _{ΔN}	U _{IΔN}	0.0 ... 70.0 V	0.1 V	0.33 · I _{ΔN} I _{ΔN} = 10 mA ... 1000 mA	5.0 ... 70.0 V	U _{IΔN} = 25, 50, 65 V	+1% rdg. + 1 d ... +(10% rdg. + 1 d)	+(1% rdg. + 1 d) ... +(9% rdg. + 1 d)	●	●	●		PRCD adapter	
	R _E	10 ... 999 Ω 1.00 ... 6.51 kΩ	1 Ω 10 Ω	I _{ΔN} = 10 mA · 1.05	Calculated value Off R _E = U _{IΔN} / I _{ΔN}		U _{IΔN} = 25, 50, 65 V							
		3 ... 999 Ω 1.00 ... 2.17 kΩ	1 Ω 0.01 kΩ	I _{ΔN} = 30 mA · 1.05										
		1 ... 651 Ω	1 Ω	I _{ΔN} = 100 mA · 1.05										
		0.3 ... 99.9 Ω 100 ... 217 Ω	0.1 Ω 1 Ω	I _{ΔN} = 300 mA · 1.05										
		0.2 ... 9.9 Ω 10 ... 130 Ω	0.1 Ω 1 Ω	I _{ΔN} = 500 mA · 1.05										
		0.2 ... 9.9 Ω 10 ... 65 Ω	0.1 Ω 1 Ω	I _{ΔN} = 1000 mA · 1.05										
	t _a	0 ... 999 ms	1 ms		0 ... 999 ms		U _N = 120, 230, 400 V f _N = 16.7, 50, 60, 200, 400 Hz	±4 ms						±3 ms
I _Δ	3.0 ... 99.9 mA 100 ... 999 mA 1.00 ... 1.30 A	0.1 mA 1 mA 0.01 A	(0.3 ... 1.3) × I _{ΔN}	3.0 mA ... 1.30 A		±(5% rdg.+3 d)	±(3.5% rdg. + 2 d)							
U	0.0 ... 99.9 V 100 ... 999 V	0.1 V 1 V	I _{ΔN} = 10 mA ... 1000 mA	2.0 ... 99.9 V 100 ... 440 V	I _{ΔN} = 10, 30, 100, 300, 500, 1000 mA AC	±(2% rdg.+5 d) ±(2% rdg. + 1 d)	±(1% rdg.+5 d) ±(1% rdg. + 1 d)							
f	15.0 ... 99.9 Hz 100 ... 999 Hz	0.1 Hz 1 Hz		15.4 ... 420 Hz		±(0.2% rdg. + 1 d)	±(0.1% rdg. + 1 d)							
ZLOOP AC/DC A	Z	0 ... 999 mΩ 1.00 ... 9.99 Ω	1 mΩ 0.01 Ω	≥ 10 A AC/DC for U=120V (-0%) U=230V (-0%) U=400V (-0%) U=690V (-0%) U=850V DC (-0%)	50 ... 999 mΩ 1.00 ... 5.00 Ω ³	U _N = 120/230 V 400/690 V AC U _N = 850 V DC f _N = DC / 16.7, 50, 60, 200, 0 Hz	±(10% rdg.+10 d) ±(6% rdg. +4 d)	±(5% rdg.+10d) ±(3% rdg.+3 d)	●	●	●			
	l _k	0.0 ... 9.9 A 10 ... 999 A 1.00 ... 9.99 kA 10.0 ... 50.0 kA	0.1 A 1 A 0.01 kA 0.1 kA		Value calculated from l _k = U/Z		Value calculated from l _k = U/Z	Value calculated from l _k = U/Z						
	U	0.0 ... 99.9 V 100 ... 999 V	0.1 V 1 V		2.0 ... 99.9 V 100 ... 440 V		±(2% rdg.+5 d) ±(2% rdg. + 1 d)	±(1% rdg.+5 d) ±(1% rdg. + 1 d)						
	f	DC; 15.0 ... 99.9 Hz 100 ... 999 Hz	0.1 Hz 1 Hz		DC; 15.4 ... 420 Hz		±(0.2% rdg. + 1 d)	±(0.1% rdg. + 1 d)						
ZLOOP DC+ A	Z	0 ... 999 mΩ 1.00 ... 9.99 Ω 10.0 ... 29.9 Ω	1 mΩ 0.01 Ω 0.1 Ω	≥ 10 A AC for U=120V (-0%) U=230V (-0%) U=400V (-0%) and 0.5 A DC (DC-L) 2.5 A DC (DC-H)	250 ... 999 mΩ 1.00 ... 5.00 Ω	U _N = 120/230 V 400 V f _N = 16.7, 50, 60, 200, 400 Hz	±(18% rdg.+30 d) ±(10% rdg.+5 d)	±(6% rdg.+50 d) ±(6% rdg.+5 d)	●	●	●			
	l _k	0.0 ... 9.9 A 10 ... 999 A 1.00 ... 9.99 kA 10.0 ... 50.0 kA	0.1 A 1 A 0.01 kA 0.1 kA		Value calculated from l _k = U/Z		Value calculated from l _k = U/Z	Value calculated from l _k = U/Z						
	U	0.0 ... 99.9 V 100 ... 999 V	0.1 V 1 V		2.0 ... 99.9 V 100 ... 440 V		±(2% rdg.+5 d) ±(2% rdg. + 1 d)	±(1% rdg.+5 d) ±(1% rdg. + 1 d)						
	f	15.0 ... 99.9 Hz 100 ... 999 Hz	0.1 Hz 1 Hz		15.4 ... 420 Hz		±(0.2% rdg. + 1 d)	±(0.1% rdg. + 1 d)						
ZLOOP Z+RLO A	Z	0.00 ... 9.99 Ω 10.0 ... 99.9 Ω	0.01 Ω 0.1 Ω	I _{LN} ≥ 10 A AC for U=120V (-0%) U=230V (-0%) U=400V (-0%) I _{NPE} = I _{ΔN} /2	0.50 ... 9.99 Ω 10.0 ... 99.9 Ω	U _N = 120/230 V 400 V f _N = 16.7, 50, 60, 200, 400 Hz	±(10% rdg.+10 d) ±(8% rdg. + 2 d)	±(4% rdg.+5d) ±(1% rdg.+1 d)	●	●	●			
	l _k	0.0 ... 9.9 A 10 ... 999 A 1.00 ... 9.99 kA 10.0 ... 50.0 kA	0.1 A 1 A 0.01 kA 0.1 kA		Value calculated from l _k = U/Z		Value calculated from l _k = U/Z	Value calculated from l _k = U/Z						
	U	0.0 ... 99.9 V 100 ... 999 V	0.1 V 1 V		2.0 ... 99.9 V 100 ... 440 V		±(2% rdg.+5 d) ±(2% rdg. + 1 d)	±(1% rdg.+5 d) ±(1% rdg. + 1 d)						
	f	15.0 ... 99.9 Hz 100 ... 999 Hz	0.1 Hz 1 Hz		15.4 ... 420 Hz		±(0.2% rdg. + 1 d)	±(0.1% rdg. + 1 d)						

Function	Measured Quantity	Display Range	Resolution	Input Impedance / Test Current	Measuring Range	Nominal Values	Measuring Uncertainty	Intrinsic Uncertainty	Connections						
									1(L)	2(N)	3(PE)	Current Clamp	Other		
ZLOOP	Z	0.6 ... 99.9 Ω 100 ... 999 Ω	0.1 Ω 1 Ω	$I_{\Delta N}/2$	10.0 ... 99.9 Ω 100 ... 999 Ω	$U_N = 120/230 V$ 400 V $f_N = 16.7, 50, 60,$ 200, 400 Hz	$\pm(10\% \text{ rdg.} + 10 \text{ d})$ $\pm(8\% \text{ rdg.} + 2 \text{ d})$	$\pm(2\% \text{ rdg.} + 2 \text{ d})$ $\pm(1\% \text{ rdg.} + 1 \text{ d})$	●	●	●				
	Ik	0.10 ... 9.99 A 10.0 ... 99.9 A 100 ... 999 A	0.01 A 0.1 A 1 A		Value calculated from $I_k = U/Z$		Value calculated from $I_k = U/Z$	Value calculated from $I_k = U/Z$							
	U	0.0 ... 99.9 V 100 ... 999 V	0.1 V 1 V		2.0 ... 99.9 V 100 ... 440 V		$\pm(2\% \text{ rdg.} + 5 \text{ d})$ $\pm(2\% \text{ rdg.} + 1 \text{ d})$	$\pm(1\% \text{ rdg.} + 5 \text{ d})$ $\pm(1\% \text{ rdg.} + 1 \text{ d})$							
	f	15.0 ... 99.9 Hz 100 ... 999 Hz	0.1 Hz 1 Hz		15.4 ... 420 Hz		$\pm(0.2\% \text{ rdg.} + 1 \text{ d})$	$\pm(0.1\% \text{ rdg.} + 1 \text{ d})$							
Ures	U, Ures	0.0 ... 99.9 V 100 ... 999 V	0.1 V 1 V	5 MΩ	2.0 ... 99.9 V 100 ... 999 V		$\pm(2\% \text{ rdg.} + 5 \text{ d})$ $\pm(2\% \text{ rdg.} + 1 \text{ d})$	$\pm(1\% \text{ rdg.} + 5 \text{ d})$ $\pm(1\% \text{ rdg.} + 1 \text{ d})$	●	●	●				
	f	DC; 15.0 ... 99.9 Hz 100 ... 999 Hz	0.1 Hz 1 Hz		DC; 15.4 ... 99.9 Hz 100 ... 420 Hz		$\pm(0.2\% \text{ rdg.} + 1 \text{ d})$	$\pm(0.1\% \text{ rdg.} + 1 \text{ d})$							
	t _U	0.0 ... 99.9 s	0.1 sec.		0.4 ... 99.9 s		$\pm(2\% \text{ rdg.} + 2 \text{ d})$	$\pm(1\% \text{ rdg.} + 1 \text{ d})$							
IMD	RL-PE ⁶	15.0 ... 99.9 kΩ 100 ... 574 kΩ 2.50 MΩ	0.1 kΩ 1 kΩ 0.01 MΩ		15.0 ... 199 kΩ 200 ... 574 kΩ 2.50 MΩ	$U_{N-IT} = 120/230 V$ 400/690 V $f_N = 16.7, 50, 60,$ 200, 400 Hz	$\pm 7\%$ $\pm 17\%$ $\pm 3\%$	$\pm 5\%$ $\pm 15\%$ $\pm 2\%$	●	●	●				
	ta	0.00 ... 9.99 s 10.0 ... 99.9 s	0.01 sec. 0.1 sec.		0.00 ... 9.99 s 10.0 ... 99.9 s		$\pm(2\% \text{ rdg.} + 2 \text{ d})$	$\pm(1\% \text{ rdg.} + 1 \text{ d})$							
	UL1PE, UL2PE, UL1LE	0.0 ... 99.9 V 100 ... 999 V	0.1 V 1 V		2.0 ... 99.9 V 100 ... 690 V		$\pm(3\% \text{ rdg.} + 5 \text{ d})$ $\pm(3\% \text{ rdg.} + 1 \text{ d})$	$\pm(2\% \text{ rdg.} + 5 \text{ d})$ $\pm(2\% \text{ rdg.} + 1 \text{ d})$							
	f	15.0 ... 99.9 Hz 100 ... 999 Hz	0.1 Hz 1 Hz		15.4 ... 420 Hz		$\pm(0.2\% \text{ rdg.} + 1 \text{ d})$	$\pm(0.1\% \text{ rdg.} + 1 \text{ d})$							
	IL-PE	0.00 ... 9.99 mA 10.0 ... 99.9 mA	0.01 mA 0.1 mA		0.10 ... 9.99 mA 10.0 ... 25.0 mA		$\pm(6\% \text{ rdg.} + 2 \text{ d})$	$\pm(3.5\% \text{ rdg.} + 2 \text{ d})$							
RCM	U _{IΔN}	0.0 ... 70.0 V	0.1 V	$0.33 \cdot I_{\Delta N}$ $I_{\Delta N} = 10 \text{ mA} \dots$ 1000 mA	5.0 ... 70.0 V	$U_N = 120, 230,$ 400 V $f_N = 16.7, 50, 60,$ 200, 400 Hz $I_{\Delta N} = 10, 30, 100, 300,$ 500, 1000 mA	$\pm(1\% \text{ rdg.} + 1 \text{ d})$... $\pm(10\% \text{ rdg.} + 1 \text{ d})$	$\pm 1\% \text{ rdg.} + 1 \text{ d}$... $\pm(9\% \text{ rdg.} + 1 \text{ d})$	●	● ²	●				
	R _E	10 ... 999 Ω 1.00 ... 6.51 kΩ	1 Ω 0.01 kΩ	$I_{\Delta N} = 10 \text{ mA} \cdot 1.05$	Calculated value Off $R_E = U_{I\Delta N} / I_{\Delta N}$										
		3 ... 999 Ω 1.00 ... 2.17 kΩ	1 Ω 0.01 kΩ	$I_{\Delta N} = 30 \text{ mA} \cdot 1.05$											
		1 ... 651 Ω	1 Ω	$I_{\Delta N} = 100 \text{ mA} \cdot 1.05$											
		0.3 ... 99.9 Ω 100 ... 217 Ω	0.1 Ω 1 Ω	$I_{\Delta N} = 300 \text{ mA} \cdot 1.05$											
	ta	0.0 ... 10.0 s	0.1 sec.		0.5 ... 10.0 s		$\pm(2\% \text{ rdg.} + 2 \text{ d})$	$\pm(1\% \text{ rdg.} + 1 \text{ d})$							
	I _Δ	0.0 ... 99.9 mA 100 ... 999 mA 1.00 ... 2.50 A	0.1 mA 1 mA 0.01 A	$I_{\Delta N} = 10 \text{ mA} \dots$ 1000 mA 	3.0 mA ... 2.50 A		$\pm(5\% \text{ rdg.} + 3 \text{ d})$	$\pm(3.5\% \text{ rdg.} + 2 \text{ d})$							
	U	0.0 ... 99.9 V 100 ... 999 V	0.1 V 1 V		2.0 ... 99.9 V 100 ... 440 V		$\pm(2\% \text{ rdg.} + 5 \text{ d})$ $\pm(2\% \text{ rdg.} + 1 \text{ d})$	$\pm(1\% \text{ rdg.} + 5 \text{ d})$ $\pm(1\% \text{ rdg.} + 1 \text{ d})$							
f	15.0 ... 99.9 Hz 100 ... 999 Hz	0.1 Hz 1 Hz	15.4 ... 99.9 Hz 100 ... 420 Hz		$\pm(0.2\% \text{ rdg.} + 1 \text{ d})$	$\pm(0.1\% \text{ rdg.} + 1 \text{ d})$									
IL	IL	1 ... 999 μA 1.00 ... 9.99 mA 10.0 ... 16.0 mA	0.1 μA 1 mA 0.1 mA	$R_s = 2 \text{ k}\Omega \pm 20 \%$	15 μA ... 999 μA 1.00 mA ... 9.99 mA 10.0 mA ... 16.0 mA		$\pm(3\% \text{ rdg.} + 4 \text{ d})$	$\pm(2\% \text{ rdg.} + 3 \text{ d})$	●	●	●				
	f	15.0 ... 99.9 Hz 100 ... 999 Hz	0.1 Hz 1 Hz		15.4 ... 99.9 Hz 100 ... 420 Hz		$\pm(0.2\% \text{ rdg.} + 1 \text{ d})$	$\pm(0.1\% \text{ rdg.} + 1 \text{ d})$							
	IL/AMP	0.00 ... 9.99 mA	0.01 mA	337 kΩ	0.20 ... 9.99 mA		$\pm(15\% \text{ rdg.} + 4 \text{ d})$	$\pm(2\% \text{ rdg.} + 5 \text{ d})$				PROF-ITEST CLIP 100mV/mA			
T % r.h.	ϑ	-9 ... 99. °C	0. °C		-10.0 °C ... +50.0 °C		$\pm \pm 2\text{ °C}$	$\pm 2\text{ °C}$					T/H sensor		
	r. h.	0.0 ... 99.9%	0.1 %		10.0 ... 90.0 %		$\pm 5\%$	$\pm 5\%$							
EX-TRA ΔU	Z _{L-N} Zoffset	0 ... 999 mΩ 1.00 ... 9.99 Ω	1 mΩ 0.01 Ω	$\geq 10 \text{ A AC/DC}$ for $U=120 \text{ V} (-0\%)$ $U=230 \text{ V} (-0\%)$ $U=400 \text{ V} (-0\%)$ $U=690 \text{ V} (-0\%)$ $U=850 \text{ V DC} (-0\%)$	50 ... 999 mΩ 1.00 ... 5.00 Ω	$U_N = 120/230 V$ 400/690 V AC $U_N = 850 \text{ V DC}$ $f_N = \text{DC} / 16.7, 50,$ 60, 200, 0 Hz	$\pm(10\% \text{ rdg.} + 10 \text{ d})$ $\pm(6\% \text{ rdg.} + 4 \text{ d})$	$\pm(5\% \text{ rdg.} + 10 \text{ d})$ $\pm(3\% \text{ rdg.} + 3 \text{ d})$	●	●	●				
	ΔU ΔU _{offset}	0.00 ... 9.99%	0.01%		Calculated value $\Delta U = (I_N \cdot Z_{LN}) / U_N \cdot 100\%$		Calculated value $\Delta U = (I_N \cdot Z_{LN}) / U_N \cdot 100\%$								
	U	0.0 ... 99.9 V 100 ... 999 V	0.1 V 1 V		2.0 ... 99.9 V 100 ... 725 V AC 100 ... 850 V DC		$\pm(2\% \text{ rdg.} + 5 \text{ d})$ $\pm(2\% \text{ rdg.} + 1 \text{ d})$	$\pm(1\% \text{ rdg.} + 5 \text{ d})$ $\pm(1\% \text{ rdg.} + 1 \text{ d})$							
	f	DC; 15.0 ... 99.9 Hz 100 ... 999 Hz	0.1 Hz 1 Hz		DC; 15.4 ... 99.9 Hz 100 ... 420 Hz		$\pm(0.2\% \text{ rdg.} + 1 \text{ d})$	$\pm(0.1\% \text{ rdg.} + 1 \text{ d})$							

¹ With a load of < 50 mΩ:
Auxiliary power: 230 V (-0% +10%), 50 Hz and the included 4 m probe cables. EN 61439-1 specifies a test current of > 10 A AC for protective conductor testing. The limit value is 0.1 Ω.



² Only required when testing with direct current

³ Depending on max. permissible touch voltage

⁴ Measuring range of the signal input at the test instrument, UE:

0 ... 1.0 V_{RMS} (0 ... 1.4 V_{Peak}) AC/DC

⁵ Tripping test conducted with:

- : as specified
- : 0.7 / 1.4 X I_{ΔN}
- : 2 X I_{ΔN}

Max. test current: 2.50 A. All entries are RMS values.



⁶ Resistance value RL-PE is a setting value, not a measured value.

Key: d = digits, rdg. = measured value (reading)

The following also applies to the PROFITEST PRIME AC (M506C)

Function	Measured Quantity	Display Range	Resolution	Input Impedance / Test Current	Measuring Range	Nominal Values	Measuring Uncertainty	Intrinsic Uncertainty	Connections					
									1(L)	2(N)	3(PE)	Current Clamp	Probe HV-P	Probe HV-P
HV	U	10 ... 999 V 1.00 ... 2.55 kV	1 V 10 V	Impedance to earth: ≥ 1 MΩ typ. ~ 15 MΩ	200 ... 999 V 1.00 ... 2.50 kV	1.0/1.5/2.0/2.5 kV	±(5% rdg.+5 d) ±(5% rdg.+5 d)	±(2.5% rdg.+5 d) ±(2.5% rdg.+5 d)					●	●
	I	1.0 ... 99.9 mA 100 ... 200 mA	0.1 mA 1 mA		1.0 ... 99.9 mA 100 ... 200 mA		±(7% rdg.+5 d) ±(7% rdg.+5 d)	±(5% rdg.+5 d) ±(5% rdg.+5 d)					●	●
	Φ	0 ... 90°	1°		0 ... 90°		±(12% v.M.+10D) ±(10% v.M.+10D)							●

Influencing Quantities and Influence Error

			EN61557-4	EN61557-2	EN61557-3	EN61557-6	EN61557-6
Abbr.	Influencing Quantity	U	RLo	Riso	ZLOOP 	RCD If 	RCD IΔN
A	Intrinsic Uncertainty	U: ±(1% rdg. +5 d) for 2.0 ... 99.9 V ±(1% rdg. +1 d) for 100 ... 999 V	±(2% rdg. + 2 d) for 0.10 ... 5.99 Ω	±(3% rdg. + 10 d) for 50 k ... 999 kΩ ±(3% rdg. + 1 d) for 1.00 MΩ ... 1.20 GΩ	±(5% rdg. +10 d) for 50 mΩ ... 999 mΩ ±(3% rdg. +3 d) for 1.00 Ω ... 5.00 Ω	±(3.5% rdg. + 2 d) for 3.0 mA ... 2.50 A	±3 ms for 5.0 ms ... 999 ms
E1	Reference position ±90°	0%	0%	0%	0%	0%	0%
E2	Supply voltage	0%	1%	1%	1%	1%	1%
E3	Temperature: 0 ... +40 °C	0.5%	1%	2.5%	1%	2.5%	5%
E4	Series interference voltage						
E5	Probe resistance					0%	0%
E6	Phase angle: 0° ... 18°				1%		
E7	Line freq.: 99% ... 101% of nominal frequency				1%		
E8	Line voltage: 85% ... 110% of nominal voltage				1%		
E9	Mains harmonics				1%		
E10	DC component				1%		

Fields with gray background: not relevant

Reference Conditions

Line voltage	230 V, deviation: ≤ 0.1%
Line frequency	50 Hz, deviation: ≤ 0.1%
Measured quantity frequency	45 ... 65 Hz
Waveform	Sine (deviation between effective and rectified value ≤ 0.1%)
Line impedance angle	cosφ = 1
Probe resistance	< 10 Ω
Auxiliary power (mains)	230 V, deviation: ≤ 10%
Auxiliary power (battery)	10.8 V, deviation: ≤ 10%
Ambient temperature	+23 °C, deviation: ≤ ±2 K
Relative humidity	40% ... 60%
Extraneous field strength	< 0.1 A/m
Load resistance	Linear, strictly ohmic





Nominal Ranges of Use

Voltage Un	
120 V (108 ... 132 V)	
230 V (196 ... 253 V)	
400 V (340 ... 440 V)	
690 V (656 ... 725 V)	
850 V DC (765 ... 893 V)	
Frequency fn	
16.7 Hz (15.4 ... 18 Hz)	
50 Hz (49.5 ... 50.5 Hz)	
60 Hz (59.4 ... 60.6 Hz)	
200 Hz (190 ... 210 Hz)	
400 Hz (380 ... 420 Hz)	
Line voltage waveform	Sinusoidal
Temperature range	0 °C ... + 40 °C
Line impedance angle	Corresponds to cosφ = 1 ... 0.95

Ambient Conditions

Charging temperature range	+10 °C ... + 45 °C
Storage temperature range	-20 °C ... + 60 °C
Operating temperature range	-5 °C ... + 50 °C
Accuracy	0 °C ... + 40 °C
Protective shutdown	> 75 °C
Relative humidity	Max. 75%, no condensation allowed
Elevation	To 2000 m

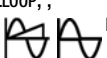
Overload Capacity

Measurement Type	Overload Capacity
U, Ures	1100 V _{RMS} continuous
RLO	Electronic protection prevents starting a measurement when interference voltage > 12 V is present.
RLoHP	Electronic protection prevents starting a measurement when interference voltage > 12 V is present. Measurement is aborted in case of test current of > 31 A. 10 s on-time, 30 s off-time
Riso 	1200 V DC continuous
IdN, IF, IdN+IF, RCM	440 V continuous
ZLOOP 	725 V AC, 893 V DC (limits the number of measurements and pause duration. If overload occurs, the measuring function is disabled by means of a thermostatic switch.)
ZLOOP, ,  I _{ΔN} ²	440 V (limits the number of measurements and pause duration. If overload occurs, the measuring function is disabled by means of a thermostatic switch.)
IMD	690 V, I _{LPE} < 25 mA continuous
IL	15 mA _{RMS} continuous, measurement is stopped in case of interference voltage > 60 V
	1 V _{RMS} continuous

Electromagnetic Compatibility

Product Standard DIN EN 61326-1:2013
 DIN EN 61326 -2-2: 2013

Interference Emission		Class
EN 55011		A
Interference Immunity	Test Value *	Evaluation Criterion
EN 61000-4-2	Contact/atmos. – 4 kV/8 kV	B
EN 61000-4-3	10 V/m	A
EN 61000-4-4	Mains connection – 2 kV	B
EN 61000-4-5	Mains connection – 2 kV	B
EN 61000-4-6	Mains connection – 3 V	A
EN 61000-4-8	30 A/m	A
EN 61000-4-11	1;250/300 periods / 100%	C

* Excerpts from EN 61326-1, table 2

Power Supply

Mains Operation

Auxiliary power
(mains connection)

85 V ... 264 V
 16.7 Hz ... 50 Hz ... 400 Hz

Power consumption

PROFITEST PRIME: < 300 VA
PROFITEST PRIME AC: < 800 VA

Mains interrupt

Mains connection socket with line disconnecter

Battery Operation

Battery pack

3 lithium-ion cells (permanently installed),
 type: FEY PA-LN1038.K01.R001
 Charging current: 1.9 A
 Charging voltage: 12.3 V
 Charging time ( switch position):
 1.5 hrs.

Nominal range of use:
 9.7 V ... 10.8 V ... 12.3 V

Number of measurements

– For RLO, 0.2 A: approx. 500
 – For Riso: approx. 1000

Standby time

32 hours



Scope of Functions Depending on Type of Power Supply

Auxiliary Power (source)	Scope of Functions				
	Load	Basic functions	RLO 25 A	HV AC	RCD DC ¹
Battery operation	✗	✓	✗	✗	✓ ²
Mains operation 230 V / 240 V ±10% 50/60 Hz ±1 Hz	✓	✓	✓	✓	✓
Mains operation 115 V ±10% 50/60 Hz ±1 Hz	✓	✓	✓	✗	✓
Mains operation 85 ... 264 V / 16.7 ... 400 Hz	✓	✓	✗	✗	✓

✓ Function available

✗ Function not possible or not sensible

¹ Functions for RCD type B, B+ and loop with DC disabling (Loop+DC)

² Performance of ZLOOP DC+  (DC-H), RCD IF  and RCD IdN measurements with DC test current is only recommended with a battery charge level of ≥ 50%.

Quick Charging Mode

No measurements can be conducted during the quick charging process. This is assured by the “Charge” position at the rotary switch.

Data Interfaces

Type USB slave for PC connection

Type RS 232 for barcode reader and T/F sensor

Type Bluetooth[®] for connection to a PC

Electrical Safety

Protection category	I and II per IEC 61010-1/ DIN EN 61010-1/VDE 0411-1
Nominal voltage	230 V
Test voltage	5.4 kV, 50 Hz (measurement connections, probe L-N-PE to mains/PE)
HV AC test voltage	Mains / PE / key switch / external signal lamp combination to high voltage measurement connections: 7.1 kV AC, 50 Hz Mains to PE: 3.0 kV AC Mains to external signal lamps: 3.0 kV AC Impedance to earth: ≥ 1 MΩ (typ. ~ 15 MΩ)
Measuring category	Power supply: CAT II, 300 V Measuring circuit / probes, basic measuring functions: 600 V CAT III / 300 V CAT IV, (without safety caps: 600 V CAT II) HV measuring circuit: 2500 V, 200 mA, HV AC potential: 2.5 kV
Pollution degree	2
Safety shutdown	In case of interference voltage and device overheating

Fuses

Mains connection	2 ea. M3.15/250V
Measuring inputs	Basic measuring functions: min. breaking capacity: 30 kA

F1	F2	F3	F4
1kV/20A	1kV/10A	1kV/2A	1kV/440mA
3-578-319-01	3-578-264-01	3-578-318-01	3-578-317-01

PRIME+AC meas. inputs **HV AC test pistols:** 5 kV, 200 mA AC

Mechanical Design

Display	Multiple display with dot matrix, b&w, 128 x 128 pixels, illuminated
Protection	Device connections: IP 40 Closed case: IP 65 per DIN EN 60529/VDE 0470-1

Excerpt from Table on the Meaning of IP Codes

IP XY (1 st digit X)	Protection Against Foreign Object Ingress	IP XY (2 nd digit Y)	Protection Against Water Ingress
4	≥ 1.0 mm Ø	0	Not protected

Dimensions	50 x 41 x 21cm (W x D x H)
Weight	PROFITEST PRIME: 10.15 kg PROFITEST PRIME AC: 15.10 kg

26 Maintenance and Recalibration

26.1 Firmware Revision and Calibration Information

See section 7.

26.2 Reset Key

If the system no longer responds, briefly press the recessed key in the front panel: 13 for the **PROFITEST PRIME**, 18 for the **PROFITEST PRIME AC**. The respective positions of the keys are shown in the operating overviews on pages 2, 3 and 4. The mains switch must be in the **OFF "0"** position. The reset function should only be used in emergencies – it results in the loss of data!

26.3 Rechargeable Battery Operation and Charging

The test instrument is equipped with an internal, rechargeable lithium-ion battery which has to be recharged at regular intervals.



Note

We recommend fully charging the batteries before lengthy periods of non-use (e.g. vacation). This prevents excessive depletion. Refer to "Safety Precautions, Rechargeable Lithium-Ion Battery" on page 12 as well.

If rechargeable battery voltage has fallen below the allowable lower limit, the pictograph shown at the right appears. "Low Batt!!!" is also displayed along with a rechargeable battery symbol. The instrument does not function if the batteries have been depleted excessively, and no display appears.



Attention!

The internal rechargeable batteries cannot be replaced by the user.

If the rechargeable batteries or battery pack have not been used or recharged for a lengthy period of time (> 1 month), thus resulting in excessive depletion:

Please note that the system clock stops in this case and must be set to the correct time after the instrument has been restarted.

26.4 Fuses



Attention!

Use only **specified, original replacement fuses!**
Short-circuiting of fuse terminals or the repair of fuses is prohibited!
Incorrect fuses may cause severe damage to the instrument.
Only original fuses from GMC-I Messtechnik GmbH assure required protection by means of suitable blowing characteristics.

26.4.1 Mains Connection Fuses

The mains connection fuses are located in a fuse holder between the inlet socket and the line disconnecter.

2 ea. M3.15/250V



Fuse Replacement



Attention!

Remove the mains power cable before opening the fuse compartment lid!

- ⇨ Pry out the fuse holder with a screwdriver – simultaneously at top and bottom.
- ⇨ Remove the blown fuse or fuses and replace with new, original fuses.
- ⇨ Reinsert the fuse holder with the new fuse. The fuse holder must audibly snap into place.

26.4.2 Measuring Circuit Fuses

The measuring circuit fuses are located between the mains connection unit and the interface connections.

If a fuse has blown due to overloading, a corresponding message error appears at the display panel. The instrument's voltage measuring ranges are nevertheless still functional.

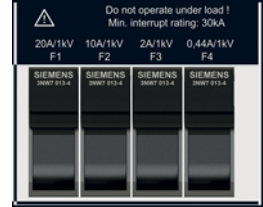

Fuse Replacement



Attention!

Disconnect the device from the measuring circuit and auxiliary power at all poles before opening the fuse compartments!

- ⇨ Determine which fuse might have blown with the help of the error message and the table included below.
- ⇨ Eliminate the cause of failure before replacing the respective fuse.
- ⇨ Pry out the respective fuse holder to a vertical position. Remove the blown fuse or fuses with the help of flat-nosed pliers and replace with new fuses.
- ⇨ Return the fuse holder to the horizontal position.

Required Fuses Depending on Measuring Function

Measuring Function	Device Fuse			
	F1	F2	F3	F4
Characteristic value >	1kV/20A	1kV/10A	1kV/2A	1kV/440mA
Order no. >	3-578-319-01	3-578-264-01	3-578-318-01	3-578-317-01
U				
RLO 0.2A	x	x		x
RLO 25A	x			
RISO	x	x		x
RISO	x	x		x
RCD – IF	x	x	x	
RCD – I _{ΔN}	x	x	x	
RCD – IF+ I _{ΔN}	x	x	x	
ZLOOP	x	x		
ZLOOP DC+	x	x	x	
ZLOOP	x	x	x	
ZLOOP	x	x		
Ures				
IMD	x	x		
RCM	x	x		
IL	x	x		x
≤1V				
T, %r.h.				
Extra				
HV				
Auto				
Setup				



Note

The voltage ranges remain functional even if fuses have blown.

26.5 Housing and Test Probes

No special maintenance is required for the housing. Keep outside surfaces clean. Use a slightly dampened cloth for cleaning. In particular for the protective rubber surfaces, we recommend a moist, lint-free microfiber cloth. Avoid the use of cleansers, abrasives or solvents.



Attention!

No **condensation** may occur at the test instrument, the test cables or the device under test, because high-voltage may otherwise cause leakage current at the surfaces. Insulated components may also conduct high-voltage in this case.

26.6 Measurement Cables

Inspect the measurement cables for mechanical damage at regular intervals.



Attention!

Even in the case of minimal damage to the test leads, we recommend sending them to GMC-I Service GmbH without delay.

26.7 Test Leads for the High-Voltage Pistols

Test leads may not, under any circumstances, be mechanically damaged or kinked, because impaired insulation characteristics may otherwise result.

Inspect the test leads and the high-voltage pistols for mechanical damage before each use.



Attention!

Even in the case of minimal damage to the test leads and the high-voltage pistols, we recommend sending them to GMC-I Service GmbH without delay.

26.8 Replacing the Bulbs in the Signal Lamp Combination (Z506B) with the PROFITEST PRIME AC



Attention!

Disconnect the signal lamp combination from the test instrument before replacing the LEDs in the respective signal lamp.

- ⇨ Unscrew the red or green lens by turning it counterclockwise.
- ⇨ Remove the defective bulb from the bayonet socket and replace it with a new bulb of the following type: 12 V DC / 3 W with base, BA15d.
- ⇨ Screw the lens back into place by turning it clockwise. After replacing a bulb, the green lens must always be screwed in closer to the connector cable.

26.9 Temperature/Humidity Sensor with Magnetic Retainer (optional)

Make sure that the connector cable doesn't get caught during measurements in control cabinets.

26.10 Recalibration

The measuring tasks performed with your instrument, and the stressing it's subjected to, influence aging of its components and may result in deviation from the specified levels of accuracy.

In the case of strict measuring accuracy requirements, as well as in the event of use at construction sites with frequent stress due to transport and considerable temperature fluctuation, we recommend a relatively short calibration interval of once per year. If your instrument is used primarily in the laboratory and indoors without considerable climatic or mechanical stressing, a calibration interval of once every 2 to 3 years is sufficient as a rule.

During recalibration* at an accredited calibration laboratory (DIN EN ISO/IEC 17025), deviations from traceable standards demonstrated by your measuring instrument are documented. Ascertained deviations are used to correct display values during later use of the instrument.

We would be happy to perform DAkkS or factory calibration for you at our calibration laboratory. Further information is available at our website:

www.gossenmetrawatt.com (→ Company → DAkkS Calibration Center or → FAQs → Questions and Answers Regarding Calibration).

Recalibration of your instrument at regular intervals is essential for the fulfillment of requirements according to quality management systems per DIN EN ISO 9001.

* Examination of the specification, as well as adjustment, are not included in calibration. However, in the case of our own products, any required adjustment is performed and adherence to the specification is confirmed.

26.11 Software

Internal test instrument software can be updated via the USB port with the help of a PC and an interface cable.

The firmware with the desired software version is transmitted to the test instrument via the USB port with the help of a firmware update tool. Previously installed software is overwritten in the process.

As a registered user (if you've registered your test instrument), you're entitled to download the **firmware update tool** and the current firmware version free of charge from the **myGMC** page at www.gossenmetrawatt.com.

You'll also find operating instructions for the **firmware update tool** here.

Downloading Procedure

- ⇨ Establish a connection between the PC and the test instrument.
- ⇨ Switch the PC and the test instrument on.

27 Appendix

27.1 Tables for Determining Maximum and Minimum Display Values in Consideration of Maximum Measuring Uncertainty

27.1.1 RLO Display Values

R _{LO} 0.2A		R _{LO} 25A			
Measured Quantity: RLO		Measured Quantity: RLO			
Limit Value [Ω]	Max. Display Value [Ω]	Limit Value [mΩ]	Max. Display Value [mΩ]	Limit Value [Ω]	Max. Display Value [Ω]
0.10	0.07	10	7		
0.20	0.17	20	17	2.00	1.90
0.30	0.26	30	26	3.00	2.86
0.40	0.36	40	36	4.00	3.82
0.50	0.46	50	46	5.00	4.78
0.60	0.55	60	55	6.00	5.74
0.70	0.65	70	65	7.00	6.70
0.80	0.74	80	74	8.00	7.66
0.90	0.84	90	84	9.00	8.62
1.00	0.94	100	94	10.0	9.40
2.00	1.90	200	190	11.0	10.3
2.00	1.90	300	286	12.0	11.3
3.00	2.86	400	382	13.0	12.2
4.00	3.82	500	478	14.0	13.2
5.00	4.78	600	574	15.0	14.2
6.00	5.74	700	670	16.0	15.1
7.00	6.70	800	766	17.0	16.1
8.00	7.66	900	862	18.0	17.0
9.00	8.62	1000	940	19.0	18.0
10.0	9.40			20.0	19.2
20.0	19.0				
30.0	28.6				
25.0	23.8				
40.0	38.2				
50.0	47.8				
60.0	57.4				
70.0	67.0				
80.0	76.6				
90.0	86.2				

27.1.2 Riso Display Values

Riso					
Measured Quantity: Riso					
Limit Value [kΩ]	Min. Display Value [kΩ]	Limit Value [MΩ]	Min. Display Value [MΩ]	Limit Value [GΩ]	Min. Display Value [GΩ]
50	63	1.00	1.07	1.00	1.07
100	115	2.00	2.12	1.05	1.13
200	220	3.00	3.17	1.10	1.18
300	325	4.00	4.22	1.15	1.23
400	430	5.00	5.27	1.20	1.28
500	535	6.00	6.32		
600	640	7.00	7.37		
700	745	8.00	8.42		
800	850	9.00	9.47		
900	955	10.0	10.7		
		20.0	21.2		
		30.0	31.7		
		40.0	42.2		
		50.0	52.7		
		60.0	63.2		
		70.0	73.7		
		80.0	84.2		
		90.0	94.7		
		100	107		
		200	212		
		300	317		
		400	422		
		500	527		
		600	632		
		700	737		
		800	842		
		900	947		

27.1.3 RCD Display Values

RCD If					
Measured Quantity: $I\Delta_N$				Measured Quantity: $UI\Delta_N$	
Limit Value [mA]	Min. Display Value [mA]	Limit Value [A]	Min. Display Value [A]	Limit Value [V]	Max. Display Value [V]
3.0	2.8	1.00	0.92	5.0	4.8
4.0	3.8	1.10	1.01	10.0	9.6
5.0	4.7	1.20	1.11	20.0	19.1
6.0	5.7	1.30	1.20	25.0	23.8
7.0	6.6	1.40	1.30	30.0	28.6
8.0	7.6	1.50	1.39	40.0	38.1
9.0	8.5	1.60	1.49	50.0	47.6
10.0	9.2	1.70	1.58	60.0	57.1
20.0	18.7	1.80	1.68	65.0	> 70
30.0	28.2	1.90	1.77	70.0	> 70
40.0	37.7	2.00	1.87		
50.0	47.2	2.10	1.96		
60.0	56.7	2.20	2.06		
70.0	66.2	2.30	2.15		
80.0	75.7	2.40	2.25		
90.0	85.2	2.50	2.34		
100	94				
200	189				
300	284				
400	379				
500	474				
600	569				
700	664				
800	759				
900	854				

RCD $I\Delta_N$			
Measured Quantity: $UI\Delta_N$		Measured Quantity: t_a	
Limit Value [V]	Max. Display Value [V]	Limit Value [ms]	Max. Display Value [ms]
5.0	4.8	5.0	1.0
10.0	9.6	6.0	2.0
20.0	19.1	7.0	3.0
25.0	23.8	8.0	4.0
30.0	28.6	9.0	5.0
40.0	38.1	9.9	5.9
50.0	47.6	10.0	6.0
60.0	57.1	20.0	16.0
65.0	> 70	30.0	26.0
70.0	> 70	40.0	36.0
		50	46
		60	56
		70	66
		80	76
		90	86
		100	96
		200	196
		300	296
		400	396
		500	496
		600	596
		700	696
		800	796
		900	896

Short-Circuit Current Minimum Display Values

for the determination of nominal current for various fuses and breakers for systems with nominal voltage of $U_N = 230\text{ V}$

Nominal Current I_N [A]	Low Resistance Fuses in accordance with the DIN VDE 0636 series of standards Characteristic gL, gG, gM				With Circuit Breaker and Line Switch							
					Characteristic B/E (formerly L)		Characteristic C (formerly G, U)		Characteristic D		Characteristic K	
	Breaking Current I_A 5 s		Breaking Current I_A 0.4 s		Breaking Current I_A $5 \times I_N$ (< 0.2 s/0.4 s)		Breaking Current I_A $10 \times I_N$ (< 0.2 s/0.4 s)		Breaking Current I_A $20 \times I_N$ (< 0.2 s/0.4 s)		Breaking Current I_A $12 \times I_N$ (< 0.1 s)	
	Limit Value [A]	Min. Display [A]	Limit Value [A]	Min. Display [A]	Limit Value [A]	Min. Display [A]	Limit Value [A]	Min. Display [A]	Limit Value [A]	Min. Display [A]	Limit Value [A]	Min. Display [A]
2	9.2	10	16	17	10	11	20	21	40	42	24	25
3	14.1	15	24	25	15	16	30	32	60	64	36	38
4	19	20	32	34	20	21	40	42	80	85	48	51
6	27	28	47	50	30	32	60	64	120	128	72	76
8	37	39	65	69	40	42	80	85	160	172	96	102
10	47	50	82	87	50	53	100	106	200	216	120	128
13	56	59	98	104	65	69	130	139	260	297	156	167
16	65	69	107	114	80	85	160	172	320	369	192	207
20	85	90	145	155	100	106	200	216	400	467	240	273
25	110	117	180	194	125	134	250	285	500	578	300	345
32	150	161	265	303	160	172	320	369	640	750	384	447
35	173	186	295	339	175	188	350	405	700	825	420	492
40	190	205	310	357	200	216	400	467	800	953	480	553
50	260	297	460	529	250	285	500	578	1000	1.22 k	600	700
63	320	369	550	639	315	363	630	737	1260	1.58 k	756	896
80	440	517									960	1.16 k
100	580	675									1200	1.49 k
125	750	889									1440	1.84 k
160	930	1.12 k									1920	2.59 k

Example

Display value 90.4 A → next smaller value for circuit breaker characteristic B from table: 85 A → protective device nominal current (I_N) max. 16 A

27.1.4 Zloop Display Values

Zloop \overline{A}			
Measured Quantity: Z			
Limit Value [m Ω]	Min. Display Value [m Ω]	Limit Value [Ω]	Min. Display Value [Ω]
50	35	1.50	1.37
100	80	2.00	1.84
200	170	2.50	2.31
300	260	3.00	2.78
400	350	3.50	3.25
500	440	4.00	3.72
600	530	4.50	4.19
700	620	5.00	4.66
800	710		
900	800		
1000	890		

Zloop DC+ \overline{A}			
Measured Quantity: Z			
Limit Value [m Ω]	Min. Display Value [m Ω]	Limit Value [Ω]	Min. Display Value [Ω]
250	175	1.50	1.32
300	216	2.00	1.77
400	298	2.50	2.22
500	380	3.00	2.67
600	462	3.50	3.12
700	544	4.00	3.57
800	626	4.50	4.02
900	708	5.00	4.47
1000	870	5.50	4.92
		6.00	5.37
		6.50	5.82
		7.00	6.27
		7.50	6.72
		8.00	7.17
		8.50	7.62
		9.00	8.07
		9.50	8.52

Zloop \overline{A}		Zloop \overline{A}	
Measured Quantity: Z			
Limit Value [Ω]	Min. Display Value [Ω]	Limit Value [Ω]	Min. Display Value [Ω]
0.50	0.35	0.6	0.4
1.00	0.80	1.0	0.8
2.00	1.70	2.0	1.7
3.00	2.60	3.0	2.6
4.00	3.50	4.0	3.5
5.00	4.40	5.0	4.4
6.00	5.30	6.0	5.3
7.00	6.20	7.0	6.2
8.00	7.10	8.0	7.1
9.00	8.00	9.0	8.0
10.0	9.0	10.0	8.9
11.0	9.9	20.0	17.9
20.0	18.2	30.0	26.9
30.0	27.4	40.0	35.9
40.0	36.6	50.0	44.9
50.0	45.8	60.0	53.9
60.0	55.0	70.0	62.9
70.0	64.2	80.0	71.9
80.0	73.4	90.0	80.9
90.0	82.6	100	90
		200	182
		300	274
		400	366
		500	458
		600	550
		700	642
		800	734
		900	826

27.1.5 Ures Display Values

Ures			
Measured Quantity: U		Measured Quantity: tu	
Limit Value [V]	Max. Display Value [V]	Limit Value [s]	Max. Display Value [s]
5	5.6	1.0	0.7
10	11.1	2.0	1.7
20	22.1	3.0	2.7
30	33.1	4.0	3.7
40	44.1	5.0	4.7
50	55.1	6.0	5.6
60	66.1	7.0	6.6
70	77.1	8.0	7.6
80	88.1	9.0	8.6
90	99.1	10.0	9.6
100	111	20.0	19.4
200	221	30.0	29.2
300	331	40.0	39.0
400	441	50.0	48.8
500	551	60.0	58.6
600	661	70.0	68.4
700	771	80.0	78.2
800	881	90.0	88.0
900	991		

27.1.6 RCM Display Values

RCM					
Measured Quantity: $I_{\Delta N}$				Measured Quantity: ta	
Limit Value [mA]	Max. Display Value [mA]	Limit Value [A]	Max. Display Value [A]	Limit Value [s]	Max. Display Value [s]
3.0	2.5	1.10	1.01	1.0	0.7
6.0	5.4	1.20	1.11	2.0	1.7
10.0	9.2	1.30	1.20	3.0	2.7
20.0	18.7	1.40	1.30	4.0	3.7
30.0	28.2	1.50	1.39	5.0	4.7
40.0	37.7	1.60	1.49	6.0	5.6
50.0	47.2	1.70	1.58	7.0	6.6
60.0	56.7	1.80	1.68	8.0	7.6
70.0	66.2	1.90	1.77	9.0	8.6
80.0	75.7	2.00	1.87	10.0	9.6
90.0	85.2	2.10	1.96		
100	94	2.20	2.06		
200	189	2.30	2.15		
300	284	2.40	2.25		
400	379	2.50	2.34		
500	474				
600	569				
700	664				
800	759				
900	854				
1000	920				

27.1.7 HV (PROFITEST PRIME AC) Display Values

HV-AC					
Measured Quantity: U				Measured Quantity: I	
Limit Value [V]	Max. Display Value [V]	Limit Value [kV]	Max. Display Value [kV]	Limit Value [mA]	Max. Display Value [mA]
10	16	1.00	1.10	10.0	8.8
20	26	1.10	1.21	20.0	18.1
30	37	1.20	1.31	30.0	27.4
40	47	1.30	1.42	40.0	36.7
50	58	1.40	1.52	50.0	46.0
60	68	1.50	1.63	60.0	55.3
70	79	1.60	1.73	70.0	64.6
80	89	1.70	1.84	80.0	73.9
90	100	1.80	1.94	90.0	83.2
100	110	1.90	2.05	100	88.0
200	215	2.00	2.15	110	97.0
300	320	2.10	2.26	120	106
400	425	2.20	2.36	130	115
500	530	2.30	2.47	140	125
600	635	2.40	> 2.50	150	134
700	740	2.50	> 2.50	160	143
800	845			170	153
900	950			180	162
				190	171
				200	181

27.2 At which values should/must an RCD actually be tripped? Requirements for Residual Current Devices (RCD)

General Requirements

- Tripping must occur no later than upon occurrence of rated residual current (nominal differential current $I_{\Delta N}$).
- and
- Maximum time to trip may not be exceeded.

Additional requirements due to influences on the tripping current range and the point in time of tripping which have to be taken into consideration:

- Residual current type or waveform:
This results in a reliable tripping current range.
- Mains type and line voltage:
This results in maximum tripping time.
- RCD variant (standard or selective):
This results in maximum tripping time.

Definitions of Requirements in the Standards

VDE 0100-600, which is included in all German standards collections for **electricians**, applies to measurements in electrical systems. It plainly states: "The effectiveness of the protective measure is substantiated when shutdown occurs no later than upon occurrence of rated differential current $I_{\Delta N}$."

As a requirement for the **measuring instrument manufacturer**, **DIN EN 61557-6 (VDE 0413-6)** unmistakably specifies:





"The measuring instrument must be capable of substantiating the fact that the residual current which trips the residual current device (RCD) is less than or equal to rated residual current."

Comment

For all electricians, this means that during required protective measures testing after system modifications or additions to the system, as well as after repairs or during the E-check conducted after measurement of touch voltage, the tripping test must be conducted no later than upon reaching a value of, depending upon the RCD, 10 mA, 30 mA, 100 mA, 300 mA or 500 mA. How does the electrician react in the event that these values are exceeded? The RCD is replaced!

If it was relatively new, a complaint is submitted to the manufacturer. And in his lab the manufacturer determines: The RCD complies with the manufacturer's standard and is OK.

A look at the VDE 0664-10/-20/-100/-200 manufacturer's standard shows us why:

Type of Residual Current	Waveform of the Residual Current	Permissible Tripping Current Range
Sinusoidal alternating current		0.5 ... 1 $I_{\Delta N}$
Pulsating direct current (positive or negative half-waves)		0.35 ... 1.4 $I_{\Delta N}$
Phase angle controlled half-wave currents Phase angle of 90° el Phase angle of 135° el		0.25 ... 1.4 $I_{\Delta N}$ 0.11 ... 1.4 $I_{\Delta N}$
Pulsating direct current superimposed with 6 mA smooth, direct residual current		Max. 1.4 $I_{\Delta N}$ + 6 mA
Smooth direct current		0.5 ... 2 $I_{\Delta N}$

Because the current waveform plays a significant role, the current waveform used by the test instrument is also important.

Set residual current type or waveform at the test instrument:

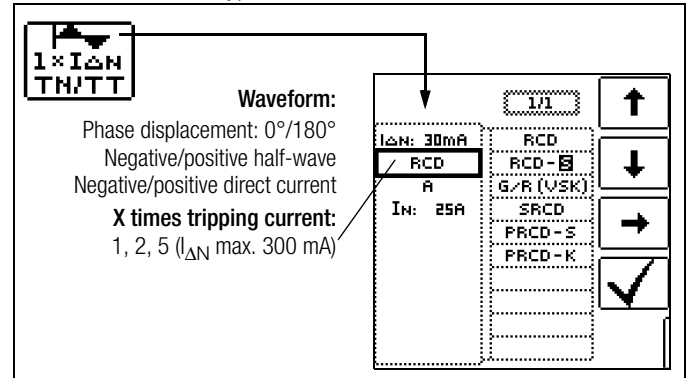

It's important to be able to select and take advantage of the corresponding settings at one's own test instrument.

The situation is similar for breaking times. The new **VDE 0100-410** should also be included in the standards collection. Depending upon mains type and line voltage, it specifies breaking times ranging from 0.1 to 5 seconds.

System	50 V < U ₀ ≤ 120 V		120 V < U ₀ ≤ 230 V		230 V < U ₀ ≤ 400 V		U ₀ > 400 V	
	AC	DC	AC	DC	AC	DC	AC	DC
TN	0.8 sec.		0.4 sec.	5 sec.	0.2 sec.	0.4 sec.	0.1 sec.	0.1 sec.
TT	0.3 sec.		0.2 sec.	0.4 sec.	0.07 sec.	0.2 sec.	0.04 sec.	0.1 sec.

RCDs usually interrupt more quickly, but in some cases they can take a bit longer. Once again, the ball is in the manufacturer's court.

The following table is also included in **VDE 0664**:

Variant	Error Current Type	Braking Time at			
		1 x $I_{\Delta N}$	2 x $I_{\Delta N}$	5 x $I_{\Delta N}$	500 A
	Alternating residual current	1 x $I_{\Delta N}$	2 x $I_{\Delta N}$	5 x $I_{\Delta N}$	500 A
	Pulsating direct residual current	1.4 x $I_{\Delta N}$	2 x 1.4 x $I_{\Delta N}$	5 x 1.4 x $I_{\Delta N}$	500 A
	Smooth, direct residual current	2 x $I_{\Delta N}$	2 x 2 x $I_{\Delta N}$	5 x 2 x $I_{\Delta N}$	500 A
	Standard (undelayed) or briefly delayed	300 ms	Max. 0.15 sec.	Max. 0.04 sec.	Max. 0.04 sec.
	Selective	0.13 ... 0.5 s	0.06 ... 0.2 s	0.05 ... 0.15 s	0.04 ... 0.15 s

Two limit values are highly conspicuous:

- Standard Max. 0.3 sec.
- Selective Max. 0.5 sec.

All of the limit values are already included in good test instruments, or it's possible to enter them directly and they're displayed as well!

Select or set limit values at the test instrument:

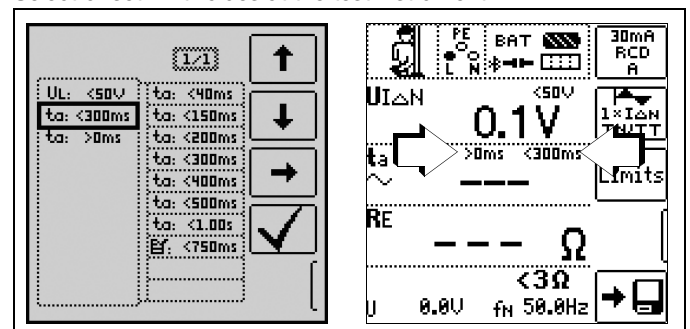

Tests for electrical systems include “visual inspection”, “testing” and “measurement”, and thus may only be conducted by experts with appropriate work experience.

In the final analysis, the values from VDE 0664 are technically binding.

27.3 Testing Electrical Machines per DIN EN 60204 – Applications, Limit Values

Comparison of Tests Specified by the Standards

Testing per DIN EN 60204-1	Testing per DIN EN 61557	Measuring Function
Continuity of the protective conductor system	Part 4: Resistance of earth connection and equipotential bonding	RLO
Testing of fault loop impedance, and for suitability of the overcurrent protective device	Part 3: Loop resistance	ZLOOP
Insulation resistance tests	Part 2: Insulation resistance	RISO 
Testing for dielectric strength	Part 14: Equipment for testing the safety of electrical equipment of machinery	HV (PROFITE ST PRIME AC only)
Protection against residual voltage	Part 14: Equipment for testing the safety of electrical equipment of machinery	Ures
Functions Tests	—	—

Uninterrupted Connection of a Protective Conductor

Uninterrupted connection of a protective conductor system is tested here by using an alternating current of 0.2 to 10 A with a line frequency of 50 Hz (= low-resistance measurement). Testing must be conducted between the mains circuit and the PE terminal (various points within the protective conductor system).

Loop Impedance Measurement

Loop impedance Z_{L-PE} is measured and short-circuit current I_K is ascertained in order to determine if the breaking requirements for protective devices have been fulfilled (see section 13). If loop measurement is not possible, e.g. where frequency converters are installed, mathematical calculation is required.

Insulation Resistance Measurement

All of the active conductors in the primary circuit are short-circuited at the machine (L and N, or L1, L2, L3 and N) and measured against PE (protective conductor). Controllers or machine components which are not laid out for these voltages (500 V DC) can be disconnected from the measuring circuit for the duration of the measurement. The measured value may not be any less than 1 MΩ. The test can be subdivided into separate segments. A maximum resistance of 50 kΩ is required for the measurement of slip-rings etc.

Test for Absence of Voltage

The electrical equipment of the machine under test must withstand a test voltage of twice its own rated voltage value or 1000 V~ (whichever is greater) applied between the conductors of all circuits and the protective conductor system for a period of at least 1 second. The test voltage must have a frequency of 50 Hz.

Residual Voltage Measurement

The EN 60204 standard specifies that after switching supply power off, residual voltage must drop to a value of 60 V or less within 5 seconds at all accessible, active components of a machine to which a voltage of greater than 60 V is applied during operation.

When conductors are exposed, residual voltage must have dropped to a value of 60 V or less within 1 second.

Function Test

The machine is operated with nominal voltage and tested for correct functioning, in particular with regard to safety functions.

Special Tests

- Pulse control mode for troubleshooting
- Protective conductor test with 25 A test current

Limit Values per DIN EN 60204-1

Measurement	Parameters	Cross-Section	Standard Value
Protective conductor measurement	Test duration		10 s
	Limit value Protective conductor resistance based on phase conductor cross-section and characteristics of the overvoltage protection device (calculated value)	1.5 mm ²	500 mΩ
		2.5 mm ²	500 mΩ
		4.0 mm ²	500 mΩ
		6.0 mm ²	400 mΩ
		10 mm ²	300 mΩ
		16 mm ²	200 mΩ
		25 mm ² L (16 mm ² PE)	200 mΩ
		35 mm ² L (16 mm ² PE)	100 mΩ
		50 mm ² L (25 mm ² PE)	100 mΩ
70 mm ² L (35 mm ² PE)		100 mΩ	
Insulation resistance measurement	Nominal voltage		500 V DC
	Resistance limit value		≥ 1 MΩ
Leakage current measurement	Leakage current		2.0 mA
Protection against residual voltage	Discharge time after switching off supply power		5 s
	Discharge time after exposing conductors		1 s
Testing for dielectric strength	Test voltage		2 x U _N or 1 kV
	Test voltage frequency		50 Hz or 60 Hz
	Test duration		1 s

Overvoltage Protection Device Characteristics for Limit Value Selection for Protective Conductor Testing

Breaking Time, Characteristics	Available for Cross-Section
Fuse breaking time: 5 s	All cross-sections
Fuse breaking time: 0.4 s	1.5 through 16 sq. mm
Circuit breaker, characteristic B $I_a = 5 \times I_n$ – breaking time: 0.1 s	1.5 through 16 sq. mm
Circuit breaker, characteristic C $I_a = 10 \times I_n$ – breaking time: 0.1 s	1.5 through 16 sq. mm
Adjustable circuit breaker $I_a = 8 \times I_n$ – breaking time: 0.1 s	All cross-sections

**27.4 Periodic Testing per DGVV Regulation 3/4
(previously BGV A3, VBG4, UVV)
– Limit Values for Electrical Systems and Operating
Equipment**

Limit Values per DIN VDE 0701-0702

Maximum Allowable Limit Values for **Protective Conductor Resistance** for Connector Cables with Lengths of up to 5 m

Test Standard	Test Current	Open-Circuit Voltage	R_{SL} Housing – Mains Plug
VDE 0701-0702:2008	> 200 mA _{ac}	4 V < U_L < 24 V	0.3 Ω ¹ + 0,1 Ω ² for each additional 7.5 m

¹ This value may not exceed 1 Ω for permanently connected data processing systems (DIN VDE 0701-0702).

² Total protective conductor resistance: max. 1 Ω

Minimum Allowable Limit Values for **Insulation Resistance**

Test Standard	Test Voltage	R_{ISO}			
		PC I	PC II	PC III	Heating
VDE 0701-0702:2008	500 V	1 M Ω	2 M Ω	0.25 M Ω	0.3 M Ω *

* With activated heating elements (where heating power > 3.5 kW and R_{ISO} < 0.3 M Ω : leakage current measurement is required)

Maximum Permissible Limit Values for **Leakage Current** in mA

Test Standard	I_{PE}	I_C	I_{DI}
VDE 0701-0702:2008	PC I: 3.5 1 mA/kW *	0.5	PC I: 3.5 1 mA/kW * PC II: 0.5

* For devices with heating power of greater than 3.5 kW

Note 1: Devices which are not equipped with accessible parts that are connected to the protective conductor, and which comply with requirements for housing leakage current and, if applicable, patient leakage current, e.g. computer equipment with shielded power pack

Note 2: Permanently connected devices with protective conductor

Note 3: Portable X-ray devices with mineral insulation

Key

I_B Housing leakage current (probe or touch current)

I_{DI} Residual current

I_{SL} Protective conductor current

Maximum Permissible Limit Values for **Equivalent Leakage Current** in mA

Test Standard	I_{EL}
VDE 0701-0702:2008	PC I: 3.5 1 mA/kW ¹ PC II: 0.5

¹ For devices with heating power \geq 3.5 kW

27.5 List of Abbreviations and their Meanings in the Order They Appear on the Rotary Switch

U – Voltage Measurement

f	Line voltage frequency
f_N	Nominal frequency
U	Voltage measured at the test probes during and after insulation measurement of RISO, or for the measurement of residual voltage U_{res}
UL-L	Voltage between two phase conductors
UL-N	Voltage between L and N
UL-PE	Voltage between L and PE
U_N	Nominal line voltage

RLO – Low-resistance of Protective, Earthing and Bonding Conductors

RLO	Resistance of equipotential bonding conductors, designated RPE
RLO+	Resistance of equipotential bonding conductors (+ pole to PE)
RLO-	Resistance of equipotential bonding conductors (- pole to PE)
U _q	Open circuit voltage
ROFFSET	Offset resistance for compensation of cables during low-resistance measurement
I _{HIGH}	High test current of 25 A for low-resistance measurement

RISO – Insulation Resistance Measurement

RISO	Insulation resistance
U _{ISO}	When measuring RISO: test voltage for ramp function: tripping or breakdown voltage
U	Voltage measured at the test probes during and after insulation measurement RISO

RCD – Testing of Residual Current Devices

I_{Δ}	Tripping current
$I_{\Delta N}$	Nominal residual current
I_N	Nominal current
$I_{F\blacktriangleleft}$	Rising test current (residual current)
I_T	Test current
RCD	RCCB (residual current circuit breaker)
PRCD	Portable residual current device PRCD-S: with protective conductor detection and monitoring PRCD-K: with undervoltage trigger and protective conductor monitoring
RCD-S	Selective RCCB
RCBO	RCCB / overcurrent protector (residual current operated circuit-breaker with overcurrent protection)
RE	Calculated earth electrode loop resistance
SRCD	Socket residual current device (permanently installed)
t_a	Time to trip / breaking time
$U_{i\Delta}$	Touch voltage at moment of tripping
$U_{i\Delta N}$	Touch voltage relative to nominal residual current $I_{\Delta N}$
UL	Touch voltage limit value

Z_{LOOP} – Loop Impedance Measurement

I_K	Calculated short-circuit current (at nominal voltage)
UL	Touch voltage limit value
Z	Loop impedance (Z_{L-N} line impedance, Z_{L-PE} loop impedance)

U_{res} Residual voltage measurement

U _{res}	Measured residual voltage after discharge time t_u , at which voltage drops to 60 V or less
------------------	---

IMD – Insulation Monitoring Device

RCM – Residual Current Monitor

IL – leakage current measurement

 $\leq 1V_{\equiv} - I_L/AMP$ leakage current (measurement with current clamp sensor)

T, %r.h. – Temperature / Atmospheric Humidity

ϑ	Temperature in °C or °F
r. H.	Relative humidity as percentage

HV – Testing for Dielectric Strength, HV AC (with the PROFITEST PRIME AC)

I _{LIM}	Maximum current which may flow before high-voltage is shut down (limit value to be specified)
I	Shutdown current for the test for dielectric strength
U _{max}	Test voltage to be specified for the test for dielectric strength
U	Momentary test probe voltage
U _D	Breakdown voltage
t_{\blacktriangleleft}	Rise time: time during which test voltage is increased to U_{max}
t_{on}	Test duration at maximum test voltage U_{max} (without rise time t_{\blacktriangleleft})

Setup – Settings Menu

U_{Batt}	(rechargeable) Battery voltage
------------	--------------------------------

Mains System

IT system	In IT systems, all active components are isolated from earth, or one point is connected to earth via an impedance. The bodies of the electrical system are grounded either individually or mutually, or are mutually connected to the system's earthing.
TT system	One point of the current source is directly grounded (French: terre terre).
TN system	As opposed to TT systems, the electrical circuit is neutralized with the consuming system in TN systems (French: terre neutre)

27.6 Keyword Index

A			
Abbreviations	120	Documentation of Fault Simulations at PRCDs with the PRO-FITEST PRCD Adapter	77
Adjusting Brightness and Contrast	22	Tripping Test, Type PRCD-K	52
Automatic Test Sequences	84	Tripping Test, Type PRCD-S	53
B		Protective Measures	
Batteries		Control Circuit	13
Charge Level	5	Inverters	13
Bibliography	122	Neutral Conductor	13
Bluetooth		PELV Circuits	13
Display Position	5	TN Systems	13
Status Displays	94		
C		R	
Charge Level	94	RCD-S	51
Connecting a Bluetooth® Keyboard	23	RCMs	66
Current Clamp Sensor		Residual Current Monitoring Devices	66
Measuring Range	70	Residual Voltage Test	62
Current limiting in the Event of Arc-Over	13		
D		S	
Data Backup	12	Safety	
DB MODE	22	Personal	13
Default Settings (GOME SETTING)	22	Safety Precautions, Rechargeable Lithium-Ion Battery	12
E		SCHUKOMAT	53
Electric Charging Stations	76	Short-Circuit Current Calculation	57
Electric Vehicles	76	Shutdown Current	
Electrical Isolation	13	at Breakdown Voltage	83
Error Acknowledgement	91	Pulse Control Mode	80
F		SIDOS	53
Firmware Revision and Calibration Information	24	Signal Generator	
Firmware Update	24	Acoustic (repetitive sequence)	79
Fuse		Signallampentest	18
Mains Connection	108	Spare key	17
Measuring Circuit	108	SRCD	53
I		Standard	
IMDs	63	DIN EN 50178 (VDE 160)	51
Insulation Monitoring Devices	63	DIN EN 60 204	118
Interfaces		DIN VDE 0100	56
Configuring Bluetooth	23	DIN VDE 0100-410	52
Internet Addresses	122	DIN VDE 0100-600	10, 57
L		IEC 61851	76
LED Signals	91, 92	NIV/NIN SEV 1000	10
Limit Values		ÖVE/ÖNORM E 8601	53
DIN EN 60204-1	118	ÖVE-EN 1	10
DINVDE0701-0702	119	VDE 0413	56
Line Voltage (display of UL-N)	56	Switching Bluetooth	
M		On/Off	23
Mains Connection Test – 3-Phase System	93	Symbol	12
Mains Connection Test – Single-Phase System	93	T	
Memory		Test Sequences	84
Occupancy Display	5	Testing	
Memory Occupancy	94	DGVU Regulation 3	119
MENNEKES Test Box	76	Electrical Machines	118
N		Touch Voltage	42
No-Trip Test	51	Type G RCCBs	53
O		U	
On-Time		User Interface Language (CULTURE)	22
LCD Illumination	22	V	
Test Instrument	22	Voltage Drop Measurement	74
Overview of Special Functions	73	Voltage Test	
P		User Interface Symbols	14
Parameter Lock	26		
Plausibility Check	26		
Polarity Reversal	28		
Power Failure	13		
PRCD			

27.7 Bibliography

Statutory Source Documents			
German occupational safety legislation (BetrSichV) Regulations issued by the accident insurance carriers			
Title	Information Rule / Regulation	Publisher	Issue / Order no.
German occupational safety legislation (BetrSichV)	BetrSichV		2015
Electrical systems and equipment	DGUV regulation 3 (formerly BGV A3)	DGUV (formerly HVBG)	2005

VDE Standards			
German standard	Title	Date of issue	Publisher
DIN VDE 0100-410	Low-voltage electrical installations – Part 410: Protection for safety – Protection against electric shock	2007-06	Beuth-Verlag GmbH
DIN VDE 0100-530	Low-voltage electrical installations – Part 530: Selection and erection of electrical equipment - Switchgear and controlgear	2011-06	Beuth-Verlag GmbH
DIN VDE 0100-600	Low-voltage electrical installations – Part 6: Tests	2008-06	Beuth-Verlag GmbH
DIN EN 61557 VDE 0413	Electrical safety in low voltage distribution systems up to 1000 V AC and 1500 V DC – Equipment for testing, measuring or monitoring of protective measures	2007-12	Beuth-Verlag GmbH
DIN VDE 0105-100	Operation of electrical installations – Part 100: General requirements	2015-10	Beuth-Verlag GmbH
DIN EN 61851-1 VDE 0122-1	Electric vehicle conductive charging system – Part 1: General requirements	2013-04	Beuth-Verlag GmbH

Further Literature in German			
Title	Author	Publisher	Issue / Order no.
Prüfung ortsfester und ortsveränderlicher Geräte	Bödeker, K. Lochthofen, M.	HUSS-MEDIEN GmbH Berlin www.elektropraktiker.de	9 th edition, 2016
DIN VDE 0100 richtig angewandt	Schmolke, H.	VDE Verlag GmbH www.vde-verlag.de	VDE series Volume 106 7 th edition, 2016
Schutz gegen elektr. Schlag DIN VDE 0100-410	Hörmann, W. Schröder, B.	VDE Verlag GmbH www.vde-verlag.de	VDE series Volume 140 4 th edition, 2010
VDE-Prüfung nach BetrSichV, TRBS und DGUV-Vorschrift 3 (BGV A3)	Henning, W.	Beuth-Verlag GmbH www.beuth.de	VDE publication series 43 2015 edition
Merkbuch für den Elektrofachmann	GMC-I Messtechnik GmbH	www.gossenmetrawatt.com	Order no. 3-337-038-01
de Jahrbuch 2014 Elektrotechnik für Handwerk und Industrie	Behrends, P.; Bonhagen, S.	Hüthig & Pflaum Verlag München/Heidelberg www.elektro.net	ISBN 978-3-8101-0350-5
Elektroinstallation für die gesamte Ausbildung	Hübscher, Jagla, Klaue, Wickert	Westermann Schulbuchverlag GmbH www.westermann.de	ISBN 978-3-14-221630-0 4 th edition, 2014
Praxis Elektrotechnik	Klaus Tkotz, Thomas Käppel, Klaus Ziegler, Peter Braukhoff, Bernd Feustel	Europa-Lehrmittel www.europa-lehrmittel.de	ISBN 978-3-8085-3266-9 13 th edition, 2015
Fachkunde Elektrotechnik		Europa-Lehrmittel www.europa-lehrmittel.de	ISBN 978-3-8085-3435-9, 30 th edition, 2016

27.7.1 Internet Addresses for Additional Information

Internet Address	
www.dguv.de	DGUV information, rules and regulations from German statutory accident insurance
www.beuth.de	VDE regulations, DIN standards, VDI directives from Beuth-Verlag GmbH
www.bgetem.de	BG information, rules and regulations from the trade associations e.g. BG ETEM (trade association for energy, textiles and electrical medical devices)
www.zveh.de	General Association of German Electricians

28 Return and Environmentally Sound Disposal

The **instrument** is a category 9 product (monitoring and control instrument) in accordance with ElektroG (German electrical and electronic device law). This device is subject to the RoHS directive. We also make reference to the fact that in this regard, the current status can be accessed on the Internet at www.gossen-metrawatt.com by entering the search term WEEE.

In accordance with WEEE 2012/19/EU and ElektroG, we identify our electrical and electronic devices with the symbol in accordance with DIN EN 50419 which is shown at the right. Devices identified with this symbol may not be disposed of with the trash. Please contact our service department regarding the return of old devices (see address in section 29).



Disposal of the Lithium-Ion Battery

If the battery inserted in your instrument is no longer efficient, it must be properly disposed of in accordance with the applicable national regulations.



Attention!

The battery may only be replaced by GMC-I Service GmbH. Otherwise the warranty expires.

The German electrical and electronic device law (ElektroG) obliges us to describe the safe removal of the installed battery in the event of the disposal of the test instrument:

- 1 As a first step, remove all cables from the front panel (especially all measurement and supply cables).
- 2 Unscrew the 17 torx screws of the front panel with a screw driver (the 4 cross-head screws may remain in place).
- 3 Separate the battery plug-in connection (1) by removing the 5-pole ribbon cable from the circuit board, see figure below. Please ensure that the battery is not short-circuited during disassembly and disposal.
- 4 Cut through the two cable ties (2).
- 5 Dispose of the battery according to the applicable regulations or return it to GMC-I Service GmbH free of charge (address see section 29).

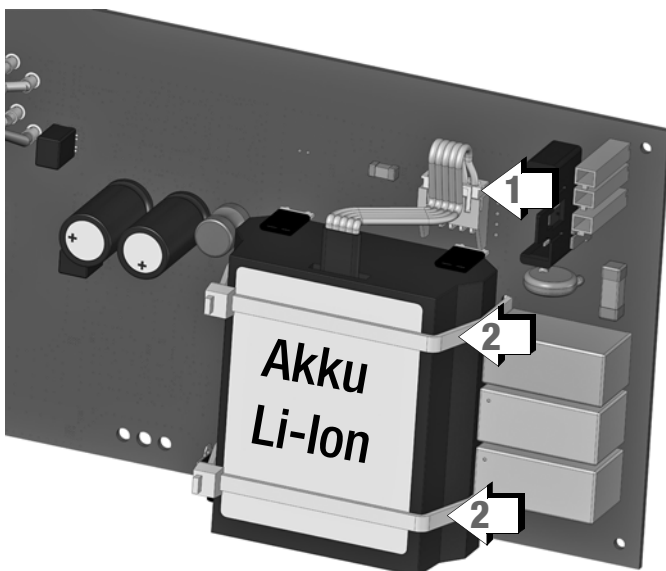

Figure: Disassembly of the Lithium-Ion Battery

29 Repair and Replacement Parts Service Calibration Center* and Rental Instrument Service

If required please contact:

GMC-I Service GmbH
Service Center
Beuthener Straße 41
90471 Nürnberg, Germany
Phone: +49-911-817718-0
Fax: +49-911-817718-253
e-mail: service@gossenmetrawatt.com
www.gmci-service.com

This address is only valid in Germany. Please contact our representatives or subsidiaries for service in other countries.

* **DAkkS calibration laboratory for electrical quantities,**
registration no. D-K-15080-01-01,
Accredited per DIN EN ISO/IEC 17025

Accredited quantities: direct voltage, direct current value, direct current resistance, alternating voltage, alternating current value, AC active power, AC apparent power, DC power, capacitance, frequency and temperature

Competent Partner

GMC-I Messtechnik GmbH is certified in accordance with DIN EN ISO 9001.

Our DAkkS calibration laboratory is accredited by the Deutsche Akkreditierungsstelle GmbH (national accreditation body for the Federal Republic of Germany) under registration number D-K-15080-01-01 in accordance with DIN EN ISO/IEC 17025.

We offer a complete range of expertise in the field of metrology: from **test reports** and **factory calibration certificates** right on up to **DAkkS calibration certificates**.

Our spectrum of offerings is rounded out with free **test equipment management**.

An **on-site DAkkS calibration station** is an integral part of our service department. If errors are discovered during calibration, our specialized personnel are capable of completing repairs using original replacement parts.

As a full service calibration laboratory, we can calibrate instruments from other manufacturers as well.

30 Product Support

If required please contact:

GMC-I Messtechnik GmbH
Product Support Hotline
Phone +49-911-8602-0
Fax: +49 911 8602-709
E-mail support@gossenmetrawatt.com